



## НАСОСНОЕ ОБОРУДОВАНИЕ

Прайс лист, версия 15.02.2023

№ Лист	№ стр.
1 CDM, CDMF вертикальные многоступенчатые насосы НОВАЯ СЕРИЯ	2
2 CDLK, CDLKF полупогружные многоступенчатые насосы	9
3 CHL, CHLF, CHLFT горизонтальные многоступенчатые центробежные насосы	16
3 CHM горизонтальные многоступенчатые центробежные насосы	20
3 HCM однонасосные установки повышения давления	22
4 TD+TD G одноступенчатые циркуляционные насосы типа "ин-лайн"	23
4 CMS(L) Циркуляционные насосы с "мокрым ротором"	27
5 SJ многоступенчатые погружные насосы из нержавеющей стали	29
5 SM многоступенчатые погружные насосы из нержавеющей стали (пластиковое рабочее колесо)	41
6 WQ погружные насосы для отвода канализационных сточных вод	45
6 WQ-X погружные насосы (Vortex колесо) для отвода канализационных сточных вод	51
7 WQ-W погружные насосы с режущим механизмом для отвода канализационных сточных вод	52
7 WQ-D погружные однофазные электронасосы для отвода канализационных сточных вод	54
8 WQ-H погружные электронасосы WQ H для отвода канализационных сточных вод	55
8 WQ-QG погружные насосы с режущим механизмом для отвода канализационных сточных вод	57
9 Принадлежности для насосов WQ (автоматические муфты, поплавки)	58
9 Компактные канализационные насосные станции NPW	60
10 SDS Погружные дренажные насосы	61
10 NES консольно-моноблочные насосы по стандарту EN733	63
11 NESO консольные насосы по стандарту EN733	66
11 SMM консольно-моноблочные насосы по стандарту ISO2858	69
12 NIS центробежные консольно-моноблочные насосы по стандарту DIN 24256	71
12 NISO центробежные консольные насосы по стандарту DIN 24256	80
13 ZS центробежные моноблочные штампованные насосы	84
13 MS горизонтальные одноступенчатые центробежные насосы из нержавеющей стали	85
14 SZ горизонтальные одноступенчатые фторопластовые центробежные насосы	86
14 WLT высокоэффективные высокорасходные насосы	87
15 SP самовсасывающие поверхностные насосы для отвода загрязненных сточных вод	88
16 ZW, ZWF малозасоряемые самовсасывающие насосы для сточных вод	90
17 QY/QYL — Самовсасывающие вихревые насосы-ФЛОТАТОРЫ из нержавеющей стали 50HZ	92
18 Трехфазные асинхронные двигатели (низковольтные)	93
19 Контроллеры с функцией частотного преобразования, датчики	98
20 Щиты управления ЩУН КНС	102
21 Запорная арматура Aikon	105



**CDMF, CDM вертикальные многоступенчатые насосы (с двигателями IE3 от 0,75кВт!!!)**

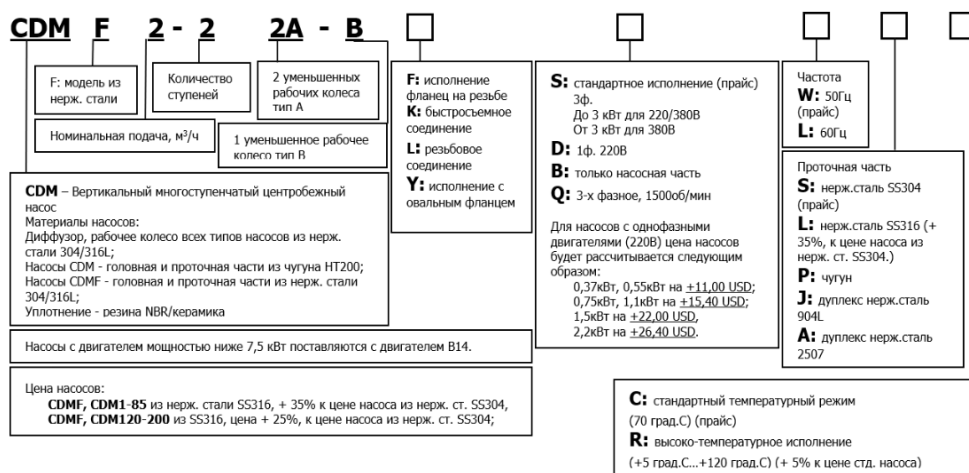

Установка датчиков РТС в обмотки электродвигателя с питающим напряжением 3х380В 50 Гц +45\$ к розничной цене.

обновление 15.02.2023

Входная, выходная камеры - чугун CI		Входная, выходная камеры -нерж. SS304		Мощность (кВт)	Заменяемая модель CDLF, CDL
Модель/арт. CDM	Цена розница (USD) с НДС	Модель/арт. CDMF	Цена розница (USD) с НДС		
<b>CDMF, CDM1</b>					
CDM1-2FSWPC IE2	369.27	CDMF1-2FSWSC IE2	457.22	0.37	CDLF, CDL 1-2
CDM1-3FSWPC IE2	455.62	CDMF1-3FSWSC IE2	542.78	0.37	CDLF, CDL 1-3
CDM1-4FSWPC IE2	483.99	CDMF1-4FSWSC IE2	571.97	0.37	CDLF, CDL 1-4
CDM1-5FSWPC IE2	535.45	CDMF1-5FSWSC IE2	623.43	0.37	CDLF, CDL 1-5
CDM1-6FSWPC IE2	597.90	CDMF1-6FSWSC IE2	686.26	0.37	CDLF, CDL 1-6
CDM1-7FSWPC IE2	638.84	CDMF1-7FSWSC IE2	726.00	0.37	CDLF, CDL 1-7
CDM1-8FSWPC IE2	684.24	CDMF1-8FSWSC IE2	772.19	0.55	CDLF, CDL 1-8
CDM1-9FSWPC IE2	706.95	CDMF1-9FSWSC IE2	794.89	0.55	CDLF, CDL 1-9
CDM1-10FSWPC IE2	740.99	CDMF1-10FSWSC IE2	828.93	0.55	CDLF, CDL 1-10
CDM1-11FSWPC IE2	792.48	CDMF1-11FSWSC IE2	880.00	0.55	CDLF, CDL 1-11
CDM1-12FSWPC	839.97	CDMF1-12FSWSC	927.82	0.75	CDLF, CDL 1-12
CDM1-13FSWPC	857.11	CDMF1-13FSWSC	945.38	0.75	CDLF, CDL 1-13
CDM1-14FSWPC	886.81	CDMF1-14FSWSC	973.75	0.75	CDLF, CDL 1-14
CDM1-15FSWPC	903.49	CDMF1-15FSWSC	990.85	0.75	CDLF, CDL 1-15

CDM1-16FSWPC	<b>921.96</b>	CDMF1-16FSWSC	<b>1 009.77</b>	1.1	CDLF, CDL 1-16
CDM1-17FSWPC	<b>928.70</b>	CDMF1-17FSWSC	<b>1 016.97</b>	1.1	CDLF, CDL 1-17
CDM1-18FSWPC	<b>942.22</b>	CDMF1-18FSWSC	<b>1 030.03</b>	1.1	CDLF, CDL 1-18
CDM1-19FSWPC	<b>1 003.91</b>	CDMF1-19FSWSC	<b>1 091.76</b>	1.1	CDLF, CDL 1-19
CDM1-20FSWPC	<b>1 026.90</b>	CDMF1-20FSWSC	<b>1 114.72</b>	1.1	CDLF, CDL 1-20
CDM1-21FSWPC	<b>1 049.87</b>	CDMF1-21FSWSC	<b>1 137.23</b>	1.1	CDLF, CDL 1-21
CDM1-22FSWPC	<b>1 092.21</b>	CDMF1-22FSWSC	<b>1 155.70</b>	1.1	CDLF, CDL 1-22
CDM1-23FSWPC	<b>1 192.18</b>	CDMF1-23FSWSC	<b>1 280.02</b>	1.5	CDLF, CDL 1-23
CDM1-24FSWPC	<b>1 202.99</b>	CDMF1-24FSWSC	<b>1 291.26</b>	1.5	CDLF, CDL 1-24
CDM1-25FSWPC	<b>1 214.26</b>	CDMF1-25FSWSC	<b>1 302.53</b>	1.5	CDLF, CDL 1-25
CDM1-26FSWPC	<b>1 233.61</b>	CDMF1-26FSWSC	<b>1 321.00</b>	1.5	CDLF, CDL 1-26
CDM1-27FSWPC	<b>1 251.62</b>	CDMF1-27FSWSC	<b>1 339.92</b>	1.5	CDLF, CDL 1-27
CDM1-28FSWPC	<b>1 261.55</b>	CDMF1-28FSWSC	<b>1 348.46</b>	1.5	CDLF, CDL 1-28
CDM1-29FSWPC	<b>1 270.09</b>	CDMF1-29FSWSC	<b>1 357.02</b>	1.5	CDLF, CDL 1-29
CDM1-30FSWPC	<b>1 279.57</b>	CDMF1-30FSWSC	<b>1 367.38</b>	1.5	CDLF, CDL 1-30
CDM1-31FSWPC	<b>1 401.62</b>	CDMF1-31FSWSC	<b>1 488.97</b>	2.2	CDLF, CDL 1-31
CDM1-32FSWPC	<b>1 525.03</b>	CDMF1-32FSWSC	<b>1 611.93</b>	2.2	CDLF, CDL 1-32
CDM1-33FSWPC	<b>1 648.42</b>	CDMF1-33FSWSC	<b>1 735.35</b>	2.2	CDLF, CDL 1-33
CDM1-34FSWPC	<b>1 677.70</b>	CDMF1-34FSWSC	<b>1 765.97</b>	2.2	CDLF, CDL 1-34
CDM1-35FSWPC	<b>1 709.23</b>	CDMF1-35FSWSC	<b>1 795.25</b>	2.2	CDLF, CDL 1-35
CDM1-36FSWPC	<b>1 738.51</b>	CDMF1-36FSWSC	<b>1 825.87</b>	2.2	CDLF, CDL 1-36
CDM1-37FSWPC	<b>1 768.25</b>	CDMF1-37FSWSC	<b>1 856.06</b>	2.2	--
CDM1-38FSWPC	<b>1 798.87</b>	CDMF1-38FSWSC	<b>1 885.77</b>	2.2	--
CDM1-39FSWPC	<b>1 828.57</b>	CDMF1-39FSWSC	<b>1 916.42</b>	2.2	--
CDM1-40FSWPC	<b>1 858.31</b>	CDMF1-40FSWSC	<b>1 946.13</b>	2.2	--
<b>CDMF, CDM3</b>					
CDM3-2FSWPC IE2	<b>406.57</b>	CDMF3-2FSWSC IE2	<b>494.12</b>	0.37	CDLF, CDL 2-2; 3-2
CDM3-3FSWPC IE2	<b>460.47</b>	CDMF3-3FSWSC IE2	<b>548.45</b>	0.37	CDLF, CDL 2-3; 3-3
CDM3-4FSWPC IE2	<b>514.80</b>	CDMF3-4FSWSC IE2	<b>603.17</b>	0.37	CDLF, CDL 3-4; 3-5
CDM3-5FSWPC IE2	<b>536.30</b>	CDMF3-5FSWSC IE2	<b>623.82</b>	0.55	CDLF, CDL 2-4; 3-6
CDM3-6FSWPC IE2	<b>565.88</b>	CDMF3-6FSWSC IE2	<b>653.85</b>	0.55	CDLF, CDL 2-5; 3-7
CDM3-7FSWPC	<b>656.23</b>	CDMF3-7FSWSC	<b>744.50</b>	0.75	CDLF, CDL 2-6; 3-8; 3-9
CDM3-8FSWPC	<b>686.85</b>	CDMF3-8FSWSC	<b>774.67</b>	0.75	CDLF, CDL 2-7; 3-10
CDM3-9FSWPC	<b>721.08</b>	CDMF3-9FSWSC	<b>808.44</b>	1.1	CDLF, CDL 2-8; 3-11
CDM3-10FSWPC	<b>741.34</b>	CDMF3-10FSWSC	<b>829.16</b>	1.1	CDLF, CDL 2-9; 3-12; 3-13
CDM3-11FSWPC	<b>789.97</b>	CDMF3-11FSWSC	<b>877.37</b>	1.1	CDLF, CDL 2-10; 3-14
CDM3-12FSWPC	<b>837.72</b>	CDMF3-12FSWSC	<b>925.54</b>	1.1	CDLF, CDL 2-11; 3-15
CDM3-13FSWPC	<b>891.31</b>	CDMF3-13FSWSC	<b>979.15</b>	1.5	CDLF, CDL 2-12; 3-16
CDM3-14FSWPC	<b>904.82</b>	CDMF3-14FSWSC	<b>991.76</b>	1.5	CDLF, CDL 2-13; 3-17; 3-18
CDM3-15FSWPC	<b>926.91</b>	CDMF3-15FSWSC	<b>1 014.72</b>	1.5	CDLF, CDL 2-14; 3-19
CDM3-16FSWPC	<b>949.42</b>	CDMF3-16FSWSC	<b>1 036.81</b>	1.5	CDLF, CDL 2-15; 3-20; 3-21
CDM3-17FSWPC	<b>969.25</b>	CDMF3-17FSWSC	<b>1 057.52</b>	2.2	CDLF, CDL 2-16; 3-22
CDM3-18FSWPC	<b>984.56</b>	CDMF3-18FSWSC	<b>1 072.83</b>	2.2	CDLF, CDL 2-17; 3-23
CDM3-19FSWPC	<b>1 000.33</b>	CDMF3-19FSWSC	<b>1 088.14</b>	2.2	CDLF, CDL 3-24; 3-25
CDM3-20FSWPC	<b>1 015.18</b>	CDMF3-20FSWSC	<b>1 102.99</b>	2.2	CDLF, CDL 2-18; 3-26
CDM3-21FSWPC	<b>1 065.63</b>	CDMF3-21FSWSC	<b>1 153.90</b>	2.2	CDLF, CDL 2-19; 3-27; 3-28
CDM3-22FSWPC	<b>1 097.16</b>	CDMF3-22FSWSC	<b>1 184.07</b>	2.2	CDLF, CDL 2-20; 3-29
CDM3-23FSWPC	<b>1 126.41</b>	CDMF3-23FSWSC	<b>1 214.72</b>	2.2	CDLF, CDL 2-21; 3-30
CDM3-24FSWPC	<b>1 156.15</b>	CDMF3-24FSWSC	<b>1 243.97</b>	2.2	CDLF, CDL 2-22; 3-31; 3-32
CDM3-25FSWPC	<b>1 193.54</b>	CDMF3-25FSWSC	<b>1 280.90</b>	3	CDLF, CDL 2-23; 3-33
CDM3-26FSWPC	<b>1 216.05</b>	CDMF3-26FSWSC	<b>1 302.99</b>	3	CDLF, CDL 2-24; 3-34

CDM3-27FSWPC	<b>1 238.14</b>	CDMF3-27FSWSC	<b>1 325.49</b>	3	CDLF, CDL 2-25; 3-35
CDM3-28FSWPC	<b>1 260.64</b>	CDMF3-28FSWSC	<b>1 347.58</b>	3	CDLF, CDL 3-36
CDM3-29FSWPC	<b>1 282.73</b>	CDMF3-29FSWSC	<b>1 370.09</b>	3	CDLF, CDL 2-26
CDM3-30FSWPC	<b>1 305.23</b>	CDMF3-30FSWSC	<b>1 392.17</b>	3	--
CDM3-31FSWPC	<b>1 327.29</b>	CDMF3-31FSWSC	<b>1 414.68</b>	3	--
<b>CDMF, CDM5</b>					
CDM5-2FSWPC IE2	<b>415.75</b>	CDMF5-2FSWSC IE2	<b>501.38</b>	0.37	--
CDM5-3FSWPC IE2	<b>472.46</b>	CDMF5-3FSWSC IE2	<b>557.57</b>	0.55	CDLF, CDL 4-2
CDM5-4FSWPC IE2	<b>526.95</b>	CDMF5-4FSWSC IE2	<b>612.06</b>	0.55	CDLF, CDL 4-3
CDM5-5FSWPC	<b>572.46</b>	CDMF5-5FSWSC	<b>657.57</b>	0.75	CDLF, CDL 4-4
CDM5-6FSWPC	<b>650.83</b>	CDMF5-6FSWSC	<b>736.39</b>	1.1	CDLF, CDL 4-5
CDM5-7FSWPC	<b>672.00</b>	CDMF5-7FSWSC	<b>758.02</b>	1.1	--
CDM5-8FSWPC	<b>707.11</b>	CDMF5-8FSWSC	<b>792.68</b>	1.1	CDLF, CDL 4-6
CDM5-9FSWPC	<b>744.05</b>	CDMF5-9FSWSC	<b>830.07</b>	1.5	CDLF, CDL 4-7
CDM5-10FSWPC	<b>812.06</b>	CDMF5-10FSWSC	<b>898.08</b>	1.5	CDLF, CDL 4-8
CDM5-11FSWPC	<b>845.84</b>	CDMF5-11FSWSC	<b>931.40</b>	1.5	CDLF, CDL 4-9
CDM5-12FSWPC	<b>894.01</b>	CDMF5-12FSWSC	<b>980.49</b>	2.2	CDLF, CDL 4-10
CDM5-13FSWPC	<b>907.53</b>	CDMF5-13FSWSC	<b>993.09</b>	2.2	CDLF, CDL 4-11
CDM5-14FSWPC	<b>921.04</b>	CDMF5-14FSWSC	<b>1 007.07</b>	2.2	--
CDM5-15FSWPC	<b>934.56</b>	CDMF5-15FSWSC	<b>1 020.13</b>	2.2	CDLF, CDL 4-12
CDM5-16FSWPC	<b>954.37</b>	CDMF5-16FSWSC	<b>1 039.97</b>	2.2	CDLF, CDL 4-13
CDM5-17FSWPC	<b>1 091.30</b>	CDMF5-17FSWSC	<b>1 177.32</b>	3	CDLF, CDL 4-14
CDM5-18FSWPC	<b>1 112.47</b>	CDMF5-18FSWSC	<b>1 198.95</b>	3	CDLF, CDL 4-15
CDM5-19FSWPC	<b>1 133.64</b>	CDMF5-19FSWSC	<b>1 219.67</b>	3	--
CDM5-20FSWPC	<b>1 155.24</b>	CDMF5-20FSWSC	<b>1 240.84</b>	3	CDLF, CDL 4-16
CDM5-21FSWPC	<b>1 257.94</b>	CDMF5-21FSWSC	<b>1 343.51</b>	3	CDLF, CDL 4-17
CDM5-22FSWPC	<b>1 424.58</b>	CDMF5-22FSWSC	<b>1 510.60</b>	4	CDLF, CDL 4-18
CDM5-23FSWPC	<b>1 471.42</b>	CDMF5-23FSWSC	<b>1 556.56</b>	4	CDLF, CDL 4-19
CDM5-24FSWPC	<b>1 517.38</b>	CDMF5-24FSWSC	<b>1 602.94</b>	4	CDLF, CDL 4-20
CDM5-25FSWPC	<b>1 564.22</b>	CDMF5-25FSWSC	<b>1 649.33</b>	4	--
CDM5-26FSWPC	<b>1 610.14</b>	CDMF5-26FSWSC	<b>1 695.71</b>	4	CDLF, CDL 4-21
CDM5-27FSWPC	<b>1 656.53</b>	CDMF5-27FSWSC	<b>1 741.67</b>	4	CDLF, CDL 4-22
CDM5-28FSWPC	<b>1 702.94</b>	CDMF5-28FSWSC	<b>1 788.51</b>	4	--
CDM5-29FSWPC	<b>1 925.87</b>	CDMF5-29FSWSC	<b>2 010.98</b>	5.5	--
CDM5-30FSWPC	<b>1 971.82</b>	CDMF5-30FSWSC	<b>2 057.39</b>	5.5	--
CDM5-31FSWPC	<b>2 018.21</b>	CDMF5-31FSWSC	<b>2 103.77</b>	5.5	--
CDM5-32FSWPC	<b>2 064.59</b>	CDMF5-32FSWSC	<b>2 150.16</b>	5.5	--
CDM5-33FSWPC	<b>2 110.52</b>	CDMF5-33FSWSC	<b>2 195.66</b>	5.5	--
<b>CDMF, CDM10</b>					
CDM10-1FSWPC	<b>627.83</b>	CDMF10-1FSWSC	<b>794.05</b>	0.75	CDLF, CDL 8-2/1; 10-1
CDM10-2FSWPC	<b>657.57</b>	CDMF10-2FSWSC	<b>824.21</b>	0.75	CDLF, CDL 8-2; 10-2
CDM10-3FSWPC	<b>743.59</b>	CDMF10-3FSWSC	<b>909.77</b>	1.1	CDLF, CDL 8-3; 10-3; 12-2
CDM10-4FSWPC	<b>867.01</b>	CDMF10-4FSWSC	<b>1 033.65</b>	1.5	CDLF, CDL 8-4; 10-4; 12-3
CDM10-5FSWPC	<b>911.60</b>	CDMF10-5FSWSC	<b>1 077.78</b>	2.2	CDLF, CDL 8-5; 10-5
CDM10-6FSWPC	<b>980.49</b>	CDMF10-6FSWSC	<b>1 145.79</b>	2.2	CDLF, CDL 8-6; 10-6; 12-4
CDM10-7FSWPC	<b>1 160.65</b>	CDMF10-7FSWSC	<b>1 327.29</b>	3	CDLF, CDL 10-7; 10-8; 12-5
CDM10-8FSWPC	<b>1 284.06</b>	CDMF10-8FSWSC	<b>1 450.70</b>	3	CDLF, CDL 8-8; 10-9; 12-6
CDM10-9FSWPC	<b>1 360.64</b>	CDMF10-9FSWSC	<b>1 526.37</b>	4	CDLF, CDL 8-9; 10-10
CDM10-10FSWPC	<b>1 681.77</b>	CDMF10-10FSWSC	<b>1 848.41</b>	4	CDLF, CDL 8-10; 8-11; 10-11; 12-7
CDM10-11FSWPC	<b>1 821.83</b>	CDMF10-11FSWSC	<b>1 988.47</b>	4	CDLF, CDL 8-12; 10-12; 12-8
CDM10-12FSWPC	<b>2 006.03</b>	CDMF10-12FSWSC	<b>2 172.70</b>	4.5	CDLF, CDL 8-13; 10-13; 12-9

CDM10-13FSWPC	<b>2 256.44</b>	CDMF10-13FSWSC	<b>2 423.11</b>	5.5	CDLF, CDL 8-14; 10-14
CDM10-14FSWPC	<b>2 292.04</b>	CDMF10-14FSWSC	<b>2 457.31</b>	5.5	CDLF, CDL 8-15; 10-15; 12-10
CDM10-15FSWPC	<b>2 369.95</b>	CDMF10-15FSWSC	<b>2 536.59</b>	5.5	CDLF, CDL 8-16; 10-16; 10-17; 12-11
CDM10-16FSWPC	<b>2 521.29</b>	CDMF10-16FSWSC	<b>2 686.59</b>	7.5	CDLF, CDL 8-17; 10-18; 12-12
CDM10-17FSWPC	<b>2 583.89</b>	CDMF10-17FSWSC	<b>2 750.53</b>	7.5	CDLF, CDL 8-18; 10-19; 12-13
CDM10-18FSWPC	<b>2 655.52</b>	CDMF10-18FSWSC	<b>2 821.70</b>	7.5	CDLF, CDL 8-19; 10-20; 12-14
CDM10-19FSWPC	<b>2 716.30</b>	CDMF10-19FSWSC	<b>2 882.06</b>	7.5	CDLF, CDL 8-20; 10-21
CDM10-20FSWPC	<b>2 781.15</b>	CDMF10-20FSWSC	<b>2 946.91</b>	7.5	CDLF, CDL 10-22; 12-15
CDM10-21FSWPC	<b>2 845.57</b>	CDMF10-21FSWSC	<b>3 011.76</b>	7.5	CDLF, CDL 12-16
CDM10-22FSWPC	<b>3 318.91</b>	CDMF10-22FSWSC	<b>3 485.13</b>	11	CDLF, CDL 12-17; 12-18
<b>CDMF, CDM15</b>					
CDM15-1FSWPC	<b>896.29</b>	CDMF15-1FSWSC	<b>1 062.93</b>	1.1	CDLF, CDL 15-1
CDM15-2FSWPC	<b>1 009.77</b>	CDMF15-2FSWSC	<b>1 176.41</b>	2.2	CDLF, CDL 15-2
CDM15-3FSWPC	<b>1 250.28</b>	CDMF15-3FSWSC	<b>1 416.47</b>	3	CDLF, CDL 15-3
CDM15-4FSWPC	<b>1 445.29</b>	CDMF15-4FSWSC	<b>1 611.05</b>	4	CDLF, CDL 15-4
CDM15-5FSWPC	<b>1 763.72</b>	CDMF15-5FSWSC	<b>1 929.94</b>	4	CDLF, CDL 15-5
CDM15-6FSWPC	<b>1 869.58</b>	CDMF15-6FSWSC	<b>2 035.31</b>	5.5	CDLF, CDL 15-6
CDM15-7FSWPC	<b>1 929.48</b>	CDMF15-7FSWSC	<b>2 094.75</b>	5.5	CDLF, CDL 15-7
CDM15-8FSWPC	<b>2 100.16</b>	CDMF15-8FSWSC	<b>2 238.88</b>	7.5	CDLF, CDL 15-8
CDM15-9FSWPC	<b>2 174.49</b>	CDMF15-9FSWSC	<b>2 340.22</b>	7.5	CDLF, CDL 15-9
CDM15-10FSWPC	<b>2 505.06</b>	CDMF15-10FSWSC	<b>2 671.28</b>	11	CDLF, CDL 15-10
CDM15-11FSWPC	<b>2 660.47</b>	CDMF15-11FSWSC	<b>2 825.74</b>	11	CDLF, CDL 15-11
CDM15-12FSWPC	<b>2 916.71</b>	CDMF15-12FSWSC	<b>3 083.38</b>	11	CDLF, CDL 15-12
CDM15-13FSWPC	<b>3 017.62</b>	CDMF15-13FSWSC	<b>3 184.26</b>	11	CDLF, CDL 15-13
CDM15-14FSWPC	<b>3 119.41</b>	CDMF15-14FSWSC	<b>3 285.14</b>	11	CDLF, CDL 15-14
CDM15-15FSWPC	<b>3 295.95</b>	CDMF15-15FSWSC	<b>3 461.71</b>	15	CDLF, CDL 15-15
CDM15-16FSWPC	<b>3 491.87</b>	CDMF15-16FSWSC	<b>3 657.63</b>	15	CDLF, CDL 15-16
CDM15-17FSWPC	<b>3 618.45</b>	CDMF15-17FSWSC	<b>3 784.63</b>	15	CDLF, CDL 15-17
CDM15-18FSWPC	<b>3 744.99</b>	CDMF15-18FSWSC	<b>3 910.75</b>	15	--
<b>CDMF, CDM20</b>					
CDM20-1FSWPC	<b>1 110.65</b>	CDMF20-1FSWSC	<b>1 279.11</b>	1.1	CDLF, CDL 20-1
CDM20-2FSWPC	<b>1 290.38</b>	CDMF20-2FSWSC	<b>1 512.43</b>	2.2	CDLF, CDL 20-2
CDM20-3FSWPC	<b>1 711.02</b>	CDMF20-3FSWSC	<b>1 906.06</b>	4	CDLF, CDL 20-3
CDM20-4FSWPC	<b>2 058.73</b>	CDMF20-4FSWSC	<b>2 254.65</b>	5.5	CDLF, CDL 20-4
CDM20-5FSWPC	<b>2 181.23</b>	CDMF20-5FSWSC	<b>2 376.27</b>	5.5	CDLF, CDL 20-5
CDM20-6FSWPC	<b>2 472.20</b>	CDMF20-6FSWSC	<b>2 668.58</b>	7.5	CDLF, CDL 20-6
CDM20-7FSWPC	<b>2 536.14</b>	CDMF20-7FSWSC	<b>2 732.52</b>	7.5	CDLF, CDL 20-7
CDM20-8FSWPC	<b>2 902.77</b>	CDMF20-8FSWSC	<b>3 086.97</b>	11	CDLF, CDL 20-8
CDM20-9FSWPC	<b>2 967.62</b>	CDMF20-9FSWSC	<b>3 152.73</b>	11	CDLF, CDL 20-9
CDM20-10FSWPC	<b>3 021.66</b>	CDMF20-10FSWSC	<b>3 217.58</b>	11	CDLF, CDL 20-10
CDM20-11FSWPC	<b>3 428.81</b>	CDMF20-11FSWSC	<b>3 613.92</b>	15	CDLF, CDL 20-11
CDM20-12FSWPC	<b>3 524.74</b>	CDMF20-12FSWSC	<b>3 719.78</b>	15	CDLF, CDL 20-12
CDM20-13FSWPC	<b>3 736.00</b>	CDMF20-13FSWSC	<b>3 921.11</b>	15	CDLF, CDL 20-13
CDM20-14FSWPC	<b>3 927.40</b>	CDMF20-14FSWSC	<b>4 122.44</b>	15	CDLF, CDL 20-14
CDM20-15FSWPC	<b>4 182.34</b>	CDMF20-15FSWSC	<b>4 386.34</b>	18.5	CDLF, CDL 20-15
CDM20-16FSWPC	<b>4 291.78</b>	CDMF20-16FSWSC	<b>4 480.02</b>	18.5	CDLF, CDL 20-16
CDM20-17FSWPC	<b>4 343.57</b>	CDMF20-17FSWSC	<b>4 533.63</b>	18.5	CDLF, CDL 20-17
<b>CDMF, CDM32</b>					
CDM32-1-1FSWPC	<b>1 520.08</b>	CDMF32-1-1FSWSC	<b>1 806.98</b>	1.5	CDLF, CDL 32-10-1
CDM32-1FSWPC	<b>1 554.74</b>	CDMF32-1FSWSC	<b>1 841.63</b>	2.2	CDLF, CDL 32-10
CDM32-2-2FSWPC	<b>1 718.67</b>	CDMF32-2-2FSWSC	<b>2 051.07</b>	3	CDLF, CDL 32-20-2

CDM32-2FSWPC	<b>1 949.28</b>	CDMF32-2FSWSC	<b>2 217.26</b>	4	CDLF, CDL 32-20
CDM32-3-2FSWPC	<b>2 475.36</b>	CDMF32-3-2FSWSC	<b>2 738.84</b>	5.5	CDLF, CDL 32-30-2
CDM32-3FSWPC	<b>2 475.36</b>	CDMF32-3FSWSC	<b>2 738.84</b>	5.5	CDLF, CDL 32-30
CDM32-4-2FSWPC	<b>2 669.00</b>	CDMF32-4-2FSWSC	<b>2 932.93</b>	7.5	CDLF, CDL 32-40-2
CDM32-4FSWPC	<b>2 669.00</b>	CDMF32-4FSWSC	<b>2 932.93</b>	7.5	CDLF, CDL 32-40
CDM32-5-2FSWPC	<b>3 267.12</b>	CDMF32-5-2FSWSC	<b>3 530.14</b>	11	CDLF, CDL 32-50-2
CDM32-5FSWPC	<b>3 267.12</b>	CDMF32-5FSWSC	<b>3 530.14</b>	11	CDLF, CDL 32-50
CDM32-6-2FSWPC	<b>3 287.84</b>	CDMF32-6-2FSWSC	<b>3 539.17</b>	11	CDLF, CDL 32-60-2
CDM32-6FSWPC	<b>3 287.84</b>	CDMF32-6FSWSC	<b>3 539.17</b>	11	CDLF, CDL 32-60
CDM32-7-2FSWPC	<b>3 773.36</b>	CDMF32-7-2FSWSC	<b>4 036.84</b>	15	CDLF, CDL 32-70-2
CDM32-7FSWPC	<b>3 773.36</b>	CDMF32-7FSWSC	<b>4 036.84</b>	15	CDLF, CDL 32-70
CDM32-8-2FSWPC	<b>3 940.46</b>	CDMF32-8-2FSWSC	<b>4 204.85</b>	15	CDLF, CDL 32-80-2
CDM32-8FSWPC	<b>3 940.46</b>	CDMF32-8FSWSC	<b>4 204.85</b>	15	CDLF, CDL 32-80
CDM32-9-2FSWPC	<b>4 489.95</b>	CDMF32-9-2FSWSC	<b>4 754.76</b>	18.5	CDLF, CDL 32-90-2
CDM32-9FSWPC	<b>4 489.95</b>	CDMF32-9FSWSC	<b>4 754.76</b>	18.5	CDLF, CDL 32-90
CDM32-10-2FSWPC	<b>4 687.66</b>	CDMF32-10-2FSWSC	<b>4 951.60</b>	18.5	CDLF, CDL 32-100-2
CDM32-10FSWPC	<b>4 687.66</b>	CDMF32-10FSWSC	<b>4 951.60</b>	18.5	CDLF, CDL 32-100
CDM32-11-2FSWPC	<b>5 397.02</b>	CDMF32-11-2FSWSC	<b>5 637.08</b>	22	CDLF, CDL 32-110-2
CDM32-11FSWPC	<b>5 397.02</b>	CDMF32-11FSWSC	<b>5 637.08</b>	22	CDLF, CDL 32-110
CDM32-12-2FSWPC	<b>5 632.13</b>	CDMF32-12-2FSWSC	<b>5 894.69</b>	22	CDLF, CDL 32-120-2
CDM32-12FSWPC	<b>5 632.13</b>	CDMF32-12FSWSC	<b>5 894.69</b>	22	CDLF, CDL 32-120
CDM32-13-2FSWPC	<b>6 409.50</b>	CDMF32-13-2FSWSC	<b>6 679.29</b>	30	CDLF, CDL 32-130-2
CDM32-13FSWPC	<b>6 409.50</b>	CDMF32-13FSWSC	<b>6 679.29</b>	30	CDLF, CDL 32-130
CDM32-14-2FSWPC	<b>6 667.57</b>	CDMF32-14-2FSWSC	<b>6 913.03</b>	30	CDLF, CDL 32-140-2
CDM32-14FSWPC	<b>6 667.57</b>	CDMF32-14FSWSC	<b>6 913.03</b>	30	CDLF, CDL 32-140
CDM32-15-2FSWPC	<b>6 974.30</b>	CDMF32-15-2FSWSC	<b>7 219.76</b>	30	CDLF, CDL 32-150-2
CDM32-15FSWPC	<b>6 974.30</b>	CDMF32-15FSWSC	<b>7 219.76</b>	30	CDLF, CDL 32-150
CDM32-16-2FSWPC	<b>7 101.30</b>	CDMF32-16-2FSWSC	<b>7 346.76</b>	30	CDLF, CDL 32-160-2
CDM32-16FSWPC	<b>7 101.30</b>	CDMF32-16FSWSC	<b>7 346.76</b>	30	CDLF, CDL 32-160
<b>CDMF, CDM42</b>					
CDM42-1-1FSWPC	<b>1 528.61</b>	CDMF42-1-1FSWSC	<b>2 260.06</b>	3	CDLF, CDL 42-10-1
CDM42-1FSWPC	<b>1 802.03</b>	CDMF42-1FSWSC	<b>2 458.68</b>	4	CDLF, CDL 42-10
CDM42-2-2FSWPC	<b>2 457.31</b>	CDMF42-2-2FSWSC	<b>2 859.97</b>	5.5	CDLF, CDL 42-20-2
CDM42-2FSWPC	<b>2 847.37</b>	CDMF42-2FSWSC	<b>3 259.93</b>	7.5	CDLF, CDL 42-20
CDM42-3-2FSWPC	<b>3 666.17</b>	CDMF42-3-2FSWSC	<b>4 184.59</b>	11	CDLF, CDL 42-30-2
CDM42-3FSWPC	<b>3 676.98</b>	CDMF42-3FSWSC	<b>4 194.49</b>	11	CDLF, CDL 42 -30
CDM42-4-2FSWPC	<b>4 691.28</b>	CDMF42-4-2FSWSC	<b>5 768.15</b>	15	CDLF, CDL 42-40-2
CDM42-4FSWPC	<b>4 702.06</b>	CDMF42-4FSWSC	<b>5 778.05</b>	15	CDLF, CDL 42-40
CDM42-5-2FSWPC	<b>5 903.72</b>	CDMF42-5-2FSWSC	<b>6 687.86</b>	18.5	CDLF, CDL 42-50-2
CDM42-5FSWPC	<b>5 914.53</b>	CDMF42-5FSWSC	<b>6 699.10</b>	18.5	CDLF, CDL 42-50
CDM42-6-2FSWPC	<b>6 821.60</b>	CDMF42-6-2FSWSC	<b>7 786.36</b>	22	CDLF, CDL 42-60-2
CDM42-6FSWPC	<b>6 831.96</b>	CDMF42-6FSWSC	<b>7 796.72</b>	22	CDLF, CDL 42-60
CDM42-7-2FSWPC	<b>7 362.07</b>	CDMF42-7-2FSWSC	<b>8 615.52</b>	30	CDLF, CDL 42-70-2
CDM42-7FSWPC	<b>7 372.89</b>	CDMF42-7FSWSC	<b>8 625.42</b>	30	CDLF, CDL 42-70
CDM42-8-2FSWPC	<b>7 627.37</b>	CDMF42-8-2FSWSC	<b>8 872.67</b>	30	CDLF, CDL 42-80-2
CDM42-8FSWPC	<b>7 638.15</b>	CDMF42-8FSWSC	<b>8 918.63</b>	30	CDLF, CDL 42-80
CDM42-9-2FSWPC	<b>7 893.98</b>	CDMF42-9-2FSWSC	<b>9 065.01</b>	30	CDLF, CDL 42-90-2
CDM42-9FSWPC	<b>8 921.79</b>	CDMF42-9FSWSC	<b>9 624.38</b>	37	CDLF, CDL 42-90
CDM42-10-2FSWPC	<b>9 177.16</b>	CDMF42-10-2FSWSC	<b>10 032.44</b>	37	CDLF, CDL 42-100-2
CDM42-10FSWPC	<b>9 187.06</b>	CDMF42-10FSWSC	<b>10 042.34</b>	37	CDLF, CDL 42-100
CDM42-11-2FSWPC	<b>11 971.37</b>	CDMF42-11-2FSWSC	<b>13 236.96</b>	45	CDLF, CDL 42-110-2

CDM42-11FSWPC	11 981.27	CDMF42-11FSWSC	13 247.77	45	CDLF, CDL 42-110
CDM42-12-2FSWPC	12 274.48	CDMF42-12-2FSWSC	13 567.99	45	CDLF, CDL 42-120-2
CDM42-12FSWPC	12 284.84	CDMF42-12FSWSC	13 577.93	45	CDLF, CDL 42-120
CDM42-13-2FSWPC	12 587.05	CDMF42-13-2FSWSC	13 905.34	45	CDLF, CDL 42-130-2
<b>CDMF, CDM65</b>					
CDM65-1-1FSWPC	1 777.24	CDMF65-1-1FSWSC	2 702.35	4	CDLF, CDL 65-10-1
CDM65-1FSWPC	2 340.67	CDMF65-1FSWSC	2 850.53	5.5	CDLF, CDL 65-10
CDM65-2-2FSWPC	2 773.07	CDMF65-2-2FSWSC	3 270.74	7.5	CDLF, CDL 65-20-2
CDM65-2-1FSWPC	3 813.91	CDMF65-2-1FSWSC	4 105.76	11	CDLF, CDL 65-20-1
CDM65-2FSWPC	3 819.74	CDMF65-2FSWSC	4 111.17	11	CDLF, CDL 65-20
CDM65-3-2FSWPC	4 839.45	CDMF65-3-2FSWSC	5 542.95	15	CDLF, CDL 65-30-2
CDM65-3-1FSWPC	4 849.35	CDMF65-3-1FSWSC	5 553.30	15	CDLF, CDL 65-30-1
CDM65-3FSWPC	5 465.94	CDMF65-3FSWSC	6 159.54	18.5	CDLF, CDL 65-30
CDM65-4-2FSWPC	5 514.12	CDMF65-4-2FSWSC	6 437.87	18.5	CDLF, CDL 65-40-2
CDM65-4-1FSWPC	6 518.06	CDMF65-4-1FSWSC	7 439.98	22	CDLF, CDL 65-40-1
CDM65-4FSWPC	6 524.35	CDMF65-4FSWSC	7 444.06	22	CDLF, CDL 65-40
CDM65-5-2FSWPC	6 987.82	CDMF65-5-2FSWSC	7 944.43	30	CDLF, CDL 65-50-2
CDM65-5-1FSWPC	6 992.77	CDMF65-5-1FSWSC	7 949.38	30	CDLF, CDL 65-50-1
CDM65-5FSWPC	6 997.72	CDMF65-5FSWSC	7 954.33	30	CDLF, CDL 65-50
CDM65-6-2FSWPC	7 280.54	CDMF65-6-2FSWSC	8 234.94	30	CDLF, CDL 65-60-2
CDM65-6-1FSWPC	8 551.12	CDMF65-6-1FSWSC	8 945.21	37	CDLF, CDL 65-60-1
CDM65-6FSWPC	8 555.62	CDMF65-6FSWSC	8 950.62	37	CDLF, CDL 65-60
CDM65-7-2FSWPC	8 690.27	CDMF65-7-2FSWSC	9 237.06	37	CDLF, CDL 65-70-2
CDM65-7-1FSWPC	8 696.13	CDMF65-7-1FSWSC	9 242.47	37	CDLF, CDL 65-70-1
CDM65-7FSWPC	10 649.49	CDMF65-7FSWSC	11 368.75	45	CDLF, CDL 65-70
CDM65-8-2FSWPC	12 061.92	CDMF65-8-2FSWSC	12 743.33	45	CDLF, CDL 65-80-2
CDM65-8-1FSWPC	12 072.70	CDMF65-8-1FSWSC	12 749.19	45	CDLF, CDL 65-80-1
<b>CDMF, CDM85</b>					
CDM85-1-1FSWPC	3 176.61	CDMF85-1-1FSWSC	4 076.02	5.5	CDLF, CDL 85-10-1
CDM85-1FSWPC	3 447.74	CDMF85-1FSWSC	4 345.82	7.5	CDLF, CDL 85-10
CDM85-2-2FSWPC	3 819.74	CDMF85-2-2FSWSC	4 816.91	11	CDLF, CDL 85-20-2
CDM85-2FSWPC	4 959.71	CDMF85-2FSWSC	5 878.50	15	CDLF, CDL 85-20
CDM85-3-2FSWPC	5 759.58	CDMF85-3-2FSWSC	6 843.68	18.5	CDLF, CDL 85-30-2
CDM85-3FSWPC	6 324.84	CDMF85-3FSWSC	7 422.43	22	CDLF, CDL 85-30
CDM85-4-2FSWPC	7 121.13	CDMF85-4-2FSWSC	8 244.84	30	CDLF, CDL 85-40-2
CDM85-4FSWPC	7 131.92	CDMF85-4FSWSC	8 255.66	30	CDLF, CDL 85-40
CDM85-5-2FSWPC	8 561.48	CDMF85-5-2FSWSC	8 983.48	37	CDLF, CDL 85-50-2
CDM85-5FSWPC	8 572.72	CDMF85-5FSWSC	8 993.84	37	CDLF, CDL 85-50
CDM85-6-2FSWPC	10 907.56	CDMF85-6-2FSWSC	11 652.48	45	CDLF, CDL 85-60-2
CDM85-6FSWPC	10 917.92	CDMF85-6FSWSC	11 662.42	45	CDLF, CDL 85-60
<b>CDMF, CDM120</b>					
CDM120-1FSWPC	по запросу	CDMF120-1FSWSC	по запросу	11	CDLF, CDL 120-10
CDM120-2-2FSWPC		CDMF120-2-2FSWSC		15	CDLF, CDL 120-20-2
CDM120-2-1FSWPC		CDMF120-2-1FSWSC		18.5	CDLF, CDL 120-20-1
CDM120-2FSWPC		CDMF120-2FSWSC		22	CDLF, CDL 120-20
CDM120-3-2FSWPC		CDMF120-3-2FSWSC		30	CDLF, CDL 120-30-2
CDM120-3-1FSWPC		CDMF120-3-1FSWSC		30	CDLF, CDL 120-30-1
CDM120-3FSWPC		CDMF120-3FSWSC		30	CDLF, CDL 120-30
CDM120-4-2FSWPC		CDMF120-4-2FSWSC		37	CDLF, CDL 120-40-2
CDM120-4-1FSWPC		CDMF120-4-1FSWSC		37	CDLF, CDL 120-40-1
CDM120-4FSWPC		CDMF120-4FSWSC		45	CDLF, CDL 120-40
CDM120-5-2FSWPC		CDMF120-5-2FSWSC		45	CDLF, CDL 120-50-2

CDM120-5-1FSWPC		CDMF120-5-1FSWSC		45	CDLF, CDL 120-50-1
CDM120-5FSWPC		CDMF120-5FSWSC		55	CDLF, CDL 120-50
CDM120-6-2FSWPC		CDMF120-6-2FSWSC		55	CDLF, CDL 120-60-2
CDM120-6-1FSWPC		CDMF120-6-1FSWSC		55	CDLF, CDL 120-60-1
CDM120-6FSWPC		CDMF120-6FSWSC		75	CDLF, CDL 120-60
CDM120-7-2FSWPC		CDMF120-7-2FSWSC		75	CDLF, CDL 120-70-2
CDM120-7-1FSWPC		CDMF120-7-1FSWSC		75	CDLF, CDL 120-70-1
CDM120-7FSWPC		CDMF120-7FSWSC		75	CDLF, CDL 120-70
<b>CDMF, CDM150</b>					
CDM150-1-1FSWPC	по запросу	CDM150-1-1FSWSC	по запросу	11	CDLF, CDL 150-10-1
CDM150-1FSWPC		CDM150-1FSWSC		15	CDLF, CDL 150-10
CDM150-2-2FSWPC		CDM150-2-2FSWSC		18.5	CDLF, CDL 150-20-2
CDM150-2-1FSWPC		CDM150-2-1FSWSC		22	CDLF, CDL 150-20-1
CDM150-2FSWPC		CDM150-2FSWSC		30	CDLF, CDL 150-20
CDM150-3-2FSWPC		CDM150-3-2FSWSC		30	CDLF, CDL 150-30-2
CDM150-3-1FSWPC		CDM150-3-1FSWSC		37	CDLF, CDL 150-30-1
CDM150-3FSWPC		CDM150-3FSWSC		37	CDLF, CDL 150-30
CDM150-4-2FSWPC		CDM150-4-2FSWSC		45	CDLF, CDL 150-40-2
CDM150-4-1FSWPC		CDM150-4-1FSWSC		45	CDLF, CDL 150-40-1
CDM150-4FSWPC		CDM150-4FSWSC		55	CDLF, CDL 150-40
CDM150-5-2FSWPC		CDM150-5-2FSWSC		55	CDLF, CDL 150-50-2
CDM150-5-1FSWPC		CDM150-5-1FSWSC		75	CDLF, CDL 150-50-1
CDM150-5FSWPC		CDM150-5FSWSC		75	CDLF, CDL 150-50
CDM150-6-2FSWPC		CDM150-6-2FSWSC		75	CDLF, CDL 150-60-2
CDM150-6-1FSWPC		CDM150-6-1FSWSC		75	CDLF, CDL 150-60-1
CDM150-6FSWPC		CDM150-6FSWSC		75	CDLF, CDL 150-60
<b>CDMF, CDM200</b>					
CDM200-1-BFSWPC	по запросу	CDMF200-1-BFSWSC	по запросу	18.5	CDLF, CDL 200-10-B
CDM200-1-AFSWPC		CDMF200-1-AFSWSC		22	CDLF, CDL 200-10-A
CDM200-1FSWPC		CDMF200-1FSWSC		30	CDLF, CDL 200-10
CDM200-2-2BFSWPC		CDMF200-2-2BFSWSC		37	CDLF, CDL 200-20-2B
CDM200-2-2AFSWPC		CDMF200-2-2AFSWSC		45	CDLF, CDL 200-20-2A
CDM200-2-AFSWPC		CDMF200-2-AFSWSC		55	CDLF, CDL 200-20-A
CDM200-2FSWPC		CDMF200-2FSWSC		55	CDLF, CDL 200-20
CDM200-3-2BFSWPC		CDMF200-3-2BFSWSC		75	CDLF, CDL 200-30-2B
CDM200-3-A-BFSWPC		CDMF200-3-A-BFSWSC		75	CDLF, CDL 200-30-A-B
CDM200-3-2AFSWPC		CDMF200-3-2AFSWSC		75	CDLF, CDL 200-30-2A
CDM200-3-BFSWPC		CDMF200-3-BFSWSC		75	CDLF, CDL 200-30-B
CDM200-3-AFSWPC		CDMF200-3-AFSWSC		75	CDLF, CDL 200-30-A
CDM200-3FSWPC		CDMF200-3FSWSC		90	CDLF, CDL 200-30
CDM200-4-2BFSWPC		CDMF200-4-2BFSWSC		90	CDLF, CDL 200-40-2B
CDM200-4-2AFSWPC		CDMF200-4-2AFSWSC		110	CDLF, CDL 200-40-2A
CDM200-4-AFSWPC		CDMF200-4-AFSWSC		110	CDLF, CDL 200-40-A
CDM200-4FSWPC		CDMF200-4FSWSC		110	CDLF, CDL 200-40



## CDLKF, CDLK

### Полупогружные многоступенчатые насосы

**CDLK F 32-120 / 12 - 2**

F: модель из нерж. стали	Количество ступеней x10	Количество рабочих колёс
Номинальная подача, м <sup>3</sup> /ч	Количество уменьшенных колёс	
<p><b>CDLK</b> – Вертикальный многоступенчатый полупогружной центробежный насос Материалы насосов: Диффузор, рабочее колесо всех типов насосов из нерж. стали 304/316L; Насосы CDLK - головная часть из чугуна HT200; Насосы CDLKF - головная часть из нерж. стали 304/316L;</p>		
<p>Цена насосов с электродвигателем IE3 рассчитывается как цена стандарт.насоса +5%</p>		

<p><b>S:</b> стандартное исполнение (прайс) 3ф. До 3 кВт для 220/380В От 3 кВт для 380В</p> <p><b>D:</b> 1ф. 220В</p> <p><b>B:</b> только насосная часть</p> <p><b>Q:</b> 3-х фазное, 1500об/мин</p> <p>Для насосов с однофазными двигателями (220В) цена насосов будет рассчитывается следующим образом: 0,37кВт, 0,55кВт на <b>+11,00 USD</b>; 0,75кВт, 1,1кВт на <b>+15,40 USD</b>; 1,5кВт на <b>+22,00 USD</b>; 2,2кВт на <b>+26,40 USD</b>.</p>	<p>Частота <b>W:</b> 50Гц (прайс) <b>L:</b> 60Гц</p> <p>Проточная часть <b>S:</b> нерж.сталь SS304 (прайс) <b>L:</b> нерж.сталь SS316 (+30%, к цене насоса из нерж. ст. SS304.) <b>P:</b> чугун <b>J:</b> дуплекс нерж.сталь 904L <b>A:</b> дуплекс нерж.сталь 2507</p>
<p><b>C:</b> стандартный температурный режим (-15 град.С...+70 град.С) (прайс) <b>R:</b> высоко-температурное исполнение (-15 град.С...+105 град.С) (+ 5% к цене std. насоса)</p>	



обновление  
15.02.2023

Входная,выходная камеры - чугун		Входная,выходная камеры -нерж. SS304		Мощность (кВт)
Артикул	Цена розница (USD) с НДС	Артикул	Цена розница (USD) с НДС	
<b>CDLK(F), CDLK1</b>				
CDLK1-20/2SWPC	444.89	CDLKF1-20/2SWSC	552.76	0.37
CDLK1-30/3SWPC	483.64	CDLKF1-30/3SWSC	591.51	0.37
CDLK1-40/4SWPC	515.08	CDLKF1-40/4SWSC	622.95	0.37
CDLK1-50/5SWPC	571.44	CDLKF1-50/5SWSC	679.32	0.37
CDLK1-60/6SWPC	639.67	CDLKF1-60/6SWSC	747.54	0.37
CDLK1-70/7SWPC	683.58	CDLKF1-70/7SWSC	791.45	0.37
CDLK1-80/8SWPC	733.41	CDLKF1-80/8SWSC	841.28	0.55
CDLK1-90/9SWPC	758.33	CDLKF1-90/9SWSC	866.21	0.55

CDLK1-100/10SWPC	795.71	CDLKF1-100/10SWSC	903.58	0.55
CDLK1-110/11SWPC	816.18	CDLKF1-110/11SWSC	924.05	0.55
CDLK1-120/12SWPC	888.85	CDLKF1-120/12SWSC	996.72	0.75
CDLK1-130/13SWPC	907.84	CDLKF1-130/13SWSC	1 015.71	0.75
CDLK1-140/14SWPC	938.69	CDLKF1-140/14SWSC	1 046.56	0.75
CDLK1-150/15SWPC	957.68	CDLKF1-150/15SWSC	1 065.55	0.75
CDLK1-160/16SWPC	967.17	CDLKF1-160/16SWSC	1 075.04	1.1
CDLK1-170/17SWPC	976.07	CDLKF1-170/17SWSC	1 083.94	1.1
CDLK1-180/18SWPC	1 017.00	CDLKF1-180/18SWSC	1 124.87	1.1
CDLK1-190/19SWPC	1 057.35	CDLKF1-190/19SWSC	1 165.22	1.1
CDLK1-200/20SWPC	1 082.27	CDLKF1-200/20SWSC	1 190.14	1.1
CDLK1-210/21SWPC	1 121.93	CDLKF1-210/21SWSC	1 229.80	1.1/1.4
CDLK1-220/22SWPC	1 194.90	CDLKF1-220/22SWSC	1 302.78	1.1/1.4
CDLK1-230/23SWPC	1 203.29	CDLKF1-230/23SWSC	1 311.16	1.1/1.4
CDLK1-240/24SWPC	1 265.00	CDLKF1-240/24SWSC	1 372.87	1.5
CDLK1-250/25SWPC	1 276.86	CDLKF1-250/25SWSC	1 384.74	1.5
CDLK1-260/26SWPC	1 297.63	CDLKF1-260/26SWSC	1 405.50	1.5
CDLK1-270/27SWPC	1 334.85	CDLKF1-270/27SWSC	1 442.72	1.5/1.8
CDLK1-280/28SWPC	1 344.94	CDLKF1-280/28SWSC	1 452.81	1.5/1.8
CDLK1-290/29SWPC	1 355.02	CDLKF1-290/29SWSC	1 462.89	1.5/1.8
CDLK1-300/30SWPC	1 365.11	CDLKF1-300/30SWSC	1 472.98	1.5/1.8
CDLK1-310/31SWPC	1 480.96	CDLKF1-310/31SWSC	1 588.83	2.2
CDLK1-320/32SWPC	1 614.45	CDLKF1-320/32SWSC	1 722.32	2.2
CDLK1-330/33SWPC	1 747.34	CDLKF1-330/33SWSC	1 855.21	2.2
CDLK1-340/34SWPC	1 779.97	CDLKF1-340/34SWSC	1 887.84	2.2
CDLK1-350/35SWPC	1 812.60	CDLKF1-350/35SWSC	1 920.47	2.2
CDLK1-360/36SWPC	1 845.24	CDLKF1-360/36SWSC	1 953.11	2.2
<b>CDLK(F), CDLK2</b>				
CDLK2-20/2SWPC	430.24	CDLKF2-20/2SWSC	538.11	0.37
CDLK2-30/3SWPC	489.57	CDLKF2-30/3SWSC	597.44	0.37
CDLK2-40/4SWPC	572.04	CDLKF2-40/4SWSC	679.91	0.55
CDLK2-50/5SWPC	604.67	CDLKF2-50/5SWSC	712.54	0.55
CDLK2-60/6SWPC	688.92	CDLKF2-60/6SWSC	796.79	0.75
CDLK2-70/7SWPC	721.55	CDLKF2-70/7SWSC	829.42	0.75
CDLK2-80/8SWPC	746.46	CDLKF2-80/8SWSC	854.34	1.1
CDLK2-90/9SWPC	771.38	CDLKF2-90/9SWSC	879.25	1.1
CDLK2-100/10SWPC	834.27	CDLKF2-100/10SWSC	942.14	1.1
CDLK2-110/11SWPC	855.86	CDLKF2-110/11SWSC	963.73	1.1/1.4
CDLK2-120/12SWPC	923.26	CDLKF2-120/12SWSC	1 031.14	1.5
CDLK2-130/13SWPC	938.69	CDLKF2-130/13SWSC	1 046.56	1.5
CDLK2-140/14SWPC	963.61	CDLKF2-140/14SWSC	1 071.48	1.5

CDLK2-150/15SWPC	<b>1 004.98</b>	CDLKF2-150/15SWSC	<b>1 112.85</b>	1.5/1.8
CDLK2-160/16SWPC	<b>1 032.86</b>	CDLKF2-160/16SWSC	<b>1 140.73</b>	2.2
CDLK2-170/17SWPC	<b>1 061.93</b>	CDLKF2-170/17SWSC	<b>1 169.80</b>	2.2
CDLK2-180/18SWPC	<b>1 072.05</b>	CDLKF2-180/18SWSC	<b>1 179.92</b>	2.2
CDLK2-190/19SWPC	<b>1 112.52</b>	CDLKF2-190/19SWSC	<b>1 220.39</b>	2.2
CDLK2-200/20SWPC	<b>1 146.34</b>	CDLKF2-200/20SWSC	<b>1 254.21</b>	2.2
CDLK2-210/21SWPC	<b>1 173.04</b>	CDLKF2-210/21SWSC	<b>1 280.91</b>	2.2
CDLK2-220/22SWPC	<b>1 200.14</b>	CDLKF2-220/22SWSC	<b>1 308.01</b>	2.2/2.6
CDLK2-230/23SWPC	<b>1 297.04</b>	CDLKF2-230/23SWSC	<b>1 404.91</b>	3
CDLK2-240/24SWPC	<b>1 324.33</b>	CDLKF2-240/24SWSC	<b>1 432.20</b>	3
CDLK2-250/25SWPC	<b>1 335.60</b>	CDLKF2-250/25SWSC	<b>1 443.47</b>	3
CDLK2-260/26SWPC	<b>1 346.87</b>	CDLKF2-260/26SWSC	<b>1 454.74</b>	3
<b>CDLK(F), CDLK3</b>				
CDLK3-20/2SWPC	<b>471.85</b>	CDLKF3-20/2SWSC	<b>579.72</b>	0.37
CDLK3-30/3SWPC	<b>515.08</b>	CDLKF3-30/3SWSC	<b>622.95</b>	0.37
CDLK3-40/4SWPC	<b>564.92</b>	CDLKF3-40/4SWSC	<b>672.79</b>	0.37
CDLK3-50/5SWPC	<b>608.82</b>	CDLKF3-50/5SWSC	<b>716.69</b>	0.37
CDLK3-60/6SWPC	<b>689.51</b>	CDLKF3-60/6SWSC	<b>797.38</b>	0.55
CDLK3-70/7SWPC	<b>714.43</b>	CDLKF3-70/7SWSC	<b>822.30</b>	0.55
CDLK3-80/8SWPC	<b>795.71</b>	CDLKF3-80/8SWSC	<b>903.58</b>	0.75
CDLK3-90/9SWPC	<b>826.56</b>	CDLKF3-90/9SWSC	<b>934.43</b>	0.75
CDLK3-100/10SWPC	<b>876.39</b>	CDLKF3-100/10SWSC	<b>984.27</b>	0.75
CDLK3-110/11SWPC	<b>920.30</b>	CDLKF3-110/11SWSC	<b>1 028.17</b>	1.1
CDLK3-120/12SWPC	<b>951.15</b>	CDLKF3-120/12SWSC	<b>1 059.02</b>	1.1
CDLK3-130/13SWPC	<b>982.59</b>	CDLKF3-130/13SWSC	<b>1 090.46</b>	1.1
CDLK3-140/14SWPC	<b>1 018.11</b>	CDLKF3-140/14SWSC	<b>1 125.98</b>	1.1
CDLK3-150/15SWPC	<b>1 068.45</b>	CDLKF3-150/15SWSC	<b>1 176.32</b>	1.1/1.4
CDLK3-160/16SWPC	<b>1 139.97</b>	CDLKF3-160/16SWSC	<b>1 247.84</b>	1.5
CDLK3-170/17SWPC	<b>1 158.80</b>	CDLKF3-170/17SWSC	<b>1 266.67</b>	1.5
CDLK3-180/18SWPC	<b>1 191.24</b>	CDLKF3-180/18SWSC	<b>1 299.11</b>	1.5
CDLK3-190/19SWPC	<b>1 240.52</b>	CDLKF3-190/19SWSC	<b>1 348.39</b>	1.5/1.8
CDLK3-200/20SWPC	<b>1 286.57</b>	CDLKF3-200/20SWSC	<b>1 394.44</b>	2.2
CDLK3-210/21SWPC	<b>1 312.46</b>	CDLKF3-210/21SWSC	<b>1 420.33</b>	2.2
CDLK3-220/22SWPC	<b>1 350.73</b>	CDLKF3-220/22SWSC	<b>1 458.60</b>	2.2
CDLK3-230/23SWPC	<b>1 389.00</b>	CDLKF3-230/23SWSC	<b>1 496.87</b>	2.2
CDLK3-240/24SWPC	<b>1 427.56</b>	CDLKF3-240/24SWSC	<b>1 535.43</b>	2.2
CDLK3-250/25SWPC	<b>1 466.12</b>	CDLKF3-250/25SWSC	<b>1 573.99</b>	2.2
CDLK3-260/26SWPC	<b>1 513.88</b>	CDLKF3-260/26SWSC	<b>1 621.75</b>	2.2
CDLK3-270/27SWPC	<b>1 584.57</b>	CDLKF3-270/27SWSC	<b>1 692.44</b>	2.2/2.6
CDLK3-280/28SWPC	<b>1 669.08</b>	CDLKF3-280/28SWSC	<b>1 776.95</b>	2.2/2.6
CDLK3-290/29SWPC	<b>1 753.06</b>	CDLKF3-290/29SWSC	<b>1 860.93</b>	2.2/2.6

CDLK3-300/30SWPC	<b>1 867.51</b>	CDLKF3-300/30SWSC	<b>1 975.38</b>	3
CDLK3-310/31SWPC	<b>1 892.70</b>	CDLKF3-310/31SWSC	<b>2 000.57</b>	3
CDLK3-320/32SWPC	<b>1 945.80</b>	CDLKF3-320/32SWSC	<b>2 053.67</b>	3
CDLK3-330/33SWPC	<b>1 998.90</b>	CDLKF3-330/33SWSC	<b>2 106.77</b>	3
CDLK3-340/34SWPC	<b>2 055.06</b>	CDLKF3-340/34SWSC	<b>2 162.93</b>	3
CDLK3-350/35SWPC	<b>2 111.22</b>	CDLKF3-350/35SWSC	<b>2 219.09</b>	3
CDLK3-360/36SWPC	<b>2 167.39</b>	CDLKF3-360/36SWSC	<b>2 275.26</b>	3

### **CDLK(F), CDLK4**

CDLK4-20/2SWPC	<b>484.23</b>	CDLKF4-20/2SWSC	<b>592.10</b>	0.37
CDLK4-30/3SWPC	<b>515.08</b>	CDLKF4-30/3SWSC	<b>622.95</b>	0.55
CDLK4-40/4SWPC	<b>610.60</b>	CDLKF4-40/4SWSC	<b>718.47</b>	0.75
CDLK4-50/5SWPC	<b>688.32</b>	CDLKF4-50/5SWSC	<b>796.19</b>	1.1
CDLK4-60/6SWPC	<b>735.79</b>	CDLKF4-60/6SWSC	<b>843.66</b>	1.1
CDLK4-70/7SWPC	<b>844.09</b>	CDLKF4-70/7SWSC	<b>951.96</b>	1.5
CDLK4-80/8SWPC	<b>858.00</b>	CDLKF4-80/8SWSC	<b>965.87</b>	1.5
CDLK4-90/9SWPC	<b>923.86</b>	CDLKF4-90/9SWSC	<b>1 031.73</b>	2.2
CDLK4-100/10SWPC	<b>947.00</b>	CDLKF4-100/10SWSC	<b>1 054.87</b>	2.2
CDLK4-110/11SWPC	<b>969.54</b>	CDLKF4-110/11SWSC	<b>1 077.41</b>	2.2
CDLK4-120/12SWPC	<b>1 015.01</b>	CDLKF4-120/12SWSC	<b>1 122.88</b>	2.2/2.6
CDLK4-130/13SWPC	<b>1 155.38</b>	CDLKF4-130/13SWSC	<b>1 263.25</b>	3
CDLK4-140/14SWPC	<b>1 164.14</b>	CDLKF4-140/14SWSC	<b>1 272.01</b>	3
CDLK4-150/15SWPC	<b>1 200.92</b>	CDLKF4-150/15SWSC	<b>1 308.79</b>	3
CDLK4-160/16SWPC	<b>1 235.33</b>	CDLKF4-160/16SWSC	<b>1 343.21</b>	3
CDLK4-170/17SWPC	<b>1 415.47</b>	CDLKF4-170/17SWSC	<b>1 523.34</b>	4
CDLK4-180/18SWPC	<b>1 475.02</b>	CDLKF4-180/18SWSC	<b>1 582.89</b>	4
CDLK4-190/19SWPC	<b>1 577.66</b>	CDLKF4-190/19SWSC	<b>1 685.53</b>	4
CDLK4-200/20SWPC	<b>1 653.01</b>	CDLKF4-200/20SWSC	<b>1 760.88</b>	4
CDLK4-210/21SWPC	<b>1 708.19</b>	CDLKF4-210/21SWSC	<b>1 816.06</b>	4
CDLK4-220/22SWPC	<b>1 837.47</b>	CDLKF4-220/22SWSC	<b>1 945.34</b>	4/4.5

### **CDLK(F), CDLK8**

CDLK8-20/2SWPC	<b>731.77</b>	CDLKF8-20/2SWSC	<b>929.10</b>	0.75
CDLK8-30/3SWPC	<b>805.63</b>	CDLKF8-30/3SWSC	<b>1 002.96</b>	1.1
CDLK8-40/4SWPC	<b>885.73</b>	CDLKF8-40/4SWSC	<b>1 083.07</b>	1.5
CDLK8-50/5SWPC	<b>980.06</b>	CDLKF8-50/5SWSC	<b>1 177.39</b>	2.2
CDLK8-60/6SWPC	<b>1 056.59</b>	CDLKF8-60/6SWSC	<b>1 253.96</b>	2.2
CDLK8-70/7SWPC	<b>1 255.94</b>	CDLKF8-70/7SWSC	<b>1 453.28</b>	3
CDLK8-80/8SWPC	<b>1 392.99</b>	CDLKF8-80/8SWSC	<b>1 590.33</b>	3
CDLK8-90/9SWPC	<b>1 592.70</b>	CDLKF8-90/9SWSC	<b>1 790.04</b>	4
CDLK8-100/10SWPC	<b>1 826.68</b>	CDLKF8-100/10SWSC	<b>2 024.02</b>	4
CDLK8-110/11SWPC	<b>1 982.12</b>	CDLKF8-110/11SWSC	<b>2 179.48</b>	4
CDLK8-120/12SWPC	<b>2 071.17</b>	CDLKF8-120/12SWSC	<b>2 268.52</b>	4/4.5

CDLK8-130/13SWPC	<b>2 310.80</b>	CDLKF8-130/13SWSC	<b>2 508.13</b>	5.5
CDLK8-140/14SWPC	<b>2 416.41</b>	CDLKF8-140/14SWSC	<b>2 613.74</b>	5.5
CDLK8-150/15SWPC	<b>2 454.97</b>	CDLKF8-150/15SWSC	<b>2 652.33</b>	5.5
CDLK8-160/16SWPC	<b>2 542.78</b>	CDLKF8-160/16SWSC	<b>2 740.11</b>	5.5
CDLK8-170/17SWPC	<b>2 701.78</b>	CDLKF8-170/17SWSC	<b>2 899.14</b>	7.5
CDLK8-180/18SWPC	<b>2 772.98</b>	CDLKF8-180/18SWSC	<b>2 970.30</b>	7.5
CDLK8-190/19SWPC	<b>2 852.48</b>	CDLKF8-190/19SWSC	<b>3 049.84</b>	7.5
CDLK8-200/20SWPC	<b>2 919.52</b>	CDLKF8-200/20SWSC	<b>3 116.86</b>	7.5
<b>CDLK(F), CDLK15</b>				
CDLK15-20/2SWPC	<b>1 087.77</b>	CDLKF15-20/2SWSC	<b>1 285.06</b>	2.2
CDLK15-30/3SWPC	<b>1 353.81</b>	CDLKF15-30/3SWSC	<b>1 551.14</b>	3
CDLK15-40/4SWPC	<b>1 560.66</b>	CDLKF15-40/4SWSC	<b>1 757.99</b>	4
CDLK15-50/5SWPC	<b>1 664.05</b>	CDLKF15-50/5SWSC	<b>1 861.34</b>	4
CDLK15-60/6SWPC	<b>2 049.75</b>	CDLKF15-60/6SWSC	<b>2 247.03</b>	5.5
CDLK15-70/7SWPC	<b>2 079.90</b>	CDLKF15-70/7SWSC	<b>2 277.23</b>	5.5
CDLK15-80/8SWPC	<b>2 314.13</b>	CDLKF15-80/8SWSC	<b>2 511.46</b>	7.5
CDLK15-90/9SWPC	<b>2 366.69</b>	CDLKF15-90/9SWSC	<b>2 564.02</b>	7.5
CDLK15-100/10SWPC	<b>2 835.63</b>	CDLKF15-100/10SWSC	<b>3 032.96</b>	11
CDLK15-110/11SWPC	<b>3 115.15</b>	CDLKF15-110/11SWSC	<b>3 312.44</b>	11
CDLK15-120/12SWPC	<b>3 227.50</b>	CDLKF15-120/12SWSC	<b>3 424.79</b>	11
CDLK15-130/13SWPC	<b>3 233.64</b>	CDLKF15-130/13SWSC	<b>3 430.93</b>	11
CDLK15-140/14SWPC	<b>3 381.75</b>	CDLKF15-140/14SWSC	<b>3 579.08</b>	11
CDLK15-150/15SWPC	<b>3 735.56</b>	CDLKF15-150/15SWSC	<b>3 932.89</b>	15
CDLK15-160/16SWPC	<b>3 875.88</b>	CDLKF15-160/16SWSC	<b>4 073.21</b>	15
CDLK15-170/17SWPC	<b>4 046.97</b>	CDLKF15-170/17SWSC	<b>4 231.95</b>	15
<b>CDLK(F), CDLK20</b>				
CDLK20-20/2SWPC	<b>1 400.16</b>	CDLKF20-20/2SWSC	<b>1 609.16</b>	2.2
CDLK20-30/3SWPC	<b>1 856.40</b>	CDLKF20-30/3SWSC	<b>2 065.41</b>	4
CDLK20-40/4SWPC	<b>2 193.98</b>	CDLKF20-40/4SWSC	<b>2 402.95</b>	5.5
CDLK20-50/5SWPC	<b>2 329.84</b>	CDLKF20-50/5SWSC	<b>2 538.83</b>	5.5
CDLK20-60/6SWPC	<b>2 646.07</b>	CDLKF20-60/6SWSC	<b>2 855.05</b>	7.5
CDLK20-70/7SWPC	<b>2 717.85</b>	CDLKF20-70/7SWSC	<b>2 926.83</b>	7.5
CDLK20-80/8SWPC	<b>3 099.93</b>	CDLKF20-80/8SWSC	<b>3 308.94</b>	11
CDLK20-90/9SWPC	<b>3 166.08</b>	CDLKF20-90/9SWSC	<b>3 375.09</b>	11
CDLK20-100/10SWPC	<b>3 232.24</b>	CDLKF20-100/10SWSC	<b>3 441.24</b>	11
CDLK20-110/11SWPC	<b>3 569.92</b>	CDLKF20-110/11SWSC	<b>3 778.92</b>	15
CDLK20-120/12SWPC	<b>3 772.13</b>	CDLKF20-120/12SWSC	<b>3 981.11</b>	15
CDLK20-130/13SWPC	<b>3 996.39</b>	CDLKF20-130/13SWSC	<b>4 205.38</b>	15
CDLK20-140/14SWPC	<b>4 220.65</b>	CDLKF20-140/14SWSC	<b>4 429.64</b>	15
CDLK20-150/15SWPC	<b>4 431.98</b>	CDLKF20-150/15SWSC	<b>4 640.99</b>	18.5
CDLK20-160/16SWPC	<b>4 527.15</b>	CDLKF20-160/16SWSC	<b>4 736.14</b>	18.5

CDLK20-170/17SWPC	<b>4 622.31</b>	CDLKF20-170/17SWSC	<b>4 831.29</b>	18.5
<b>CDLK(F), CDLK32</b>				
CDLK32-10-1/1-1SWPC	<b>1 669.25</b>	CDLKF32-10-1/1-1SWSC	<b>1 984.17</b>	1.5
CDLK32-10/1SWPC	<b>1 706.56</b>	CDLKF32-10/1SWSC	<b>2 021.48</b>	2.2
CDLK32-20/2-2SWPC	<b>1 998.65</b>	CDLKF32-20/2-2SWSC	<b>2 313.57</b>	3
CDLK32-20/2SWPC	<b>2 303.92</b>	CDLKF32-20/2SWSC	<b>2 618.84</b>	4
CDLK32-30/3SWPC	<b>2 742.43</b>	CDLKF32-30/3SWSC	<b>3 057.35</b>	5.5
CDLK32-40/4SWPC	<b>2 957.05</b>	CDLKF32-40/4SWSC	<b>3 271.97</b>	7.5
CDLK32-50/5SWPC	<b>3 374.47</b>	CDLKF32-50/5SWSC	<b>3 689.39</b>	11
CDLK32-60/6SWPC	<b>3 502.95</b>	CDLKF32-60/6SWSC	<b>3 817.86</b>	11
CDLK32-70/7SWPC	<b>4 039.43</b>	CDLKF32-70/7SWSC	<b>4 354.35</b>	15
CDLK32-80/8SWPC	<b>4 226.19</b>	CDLKF32-80/8SWSC	<b>4 541.11</b>	15
CDLK32-90/9SWPC	<b>4 778.74</b>	CDLKF32-90/9SWSC	<b>5 093.66</b>	18.5
CDLK32-100/10SWPC	<b>4 998.81</b>	CDLKF32-100/10SWSC	<b>5 313.72</b>	18.5
CDLK32-110/11SWPC	<b>5 750.01</b>	CDLKF32-110/11SWSC	<b>6 064.93</b>	22
CDLK32-120/12SWPC	<b>6 037.88</b>	CDLKF32-120/12SWSC	<b>6 352.80</b>	22
CDLK32-130/13SWPC	<b>7 828.73</b>	CDLKF32-130/13SWSC	<b>8 143.65</b>	30
CDLK32-140/14SWPC	<b>8 090.43</b>	CDLKF32-140/14SWSC	<b>8 405.35</b>	30
<b>CDLK(F), CDLK42</b>				
CDLK42-10/1-1SWPC	<b>2 247.94</b>	CDLKF42-10/1-1SWSC	<b>2 573.23</b>	3
CDLK42-10/1SWPC	<b>2 372.61</b>	CDLKF42-10/1SWSC	<b>2 697.90</b>	4
CDLK42-20/2-2SWPC	<b>3 174.24</b>	CDLKF42-20/2-2SWSC	<b>3 499.53</b>	5.5
CDLK42-20 /2 SWPC	<b>3 208.27</b>	CDLKF42-20 /2 SWSC	<b>3 533.56</b>	7.5
CDLK42-30/3-2SWPC	<b>4 225.93</b>	CDLKF42-30/3-2SWSC	<b>4 551.22</b>	11
CDLK42 -30/3SWPC	<b>4 225.93</b>	CDLKF42 -30/3SWSC	<b>4 551.22</b>	11
CDLK42-40/4-2SWPC	<b>5 974.57</b>	CDLKF42-40/4-2SWSC	<b>6 299.86</b>	15
CDLK42-40/4SWPC	<b>5 974.57</b>	CDLKF42-40/4SWSC	<b>6 299.86</b>	15
CDLK42-50/5-2SWPC	<b>6 941.08</b>	CDLKF42-50/5-2SWSC	<b>7 266.37</b>	18.5
CDLK42-50/5SWPC	<b>6 941.08</b>	CDLKF42-50/5SWSC	<b>7 266.37</b>	18.5
CDLK42-60/6-2SWPC	<b>7 725.87</b>	CDLKF42-60/6-2SWSC	<b>8 051.17</b>	22
CDLK42-60 /6 SWPC	<b>7 725.87</b>	CDLKF42-60 /6 SWSC	<b>8 051.17</b>	22
CDLK42-70/7-2SWPC	<b>8 968.67</b>	CDLKF42-70/7-2SWSC	<b>9 293.96</b>	30
CDLK42-70/7SWPC	<b>8 968.67</b>	CDLKF42-70/7SWSC	<b>9 293.96</b>	30
CDLK42-80/8-2SWPC	<b>9 296.39</b>	CDLKF42-80/8-2SWSC	<b>9 621.68</b>	30
CDLK42-80 /8SWPC	<b>9 296.39</b>	CDLKF42-80 /8SWSC	<b>9 621.68</b>	30
CDLK42-90/9-2SWPC	<b>9 760.30</b>	CDLKF42-90/9-2SWSC	<b>10 085.59</b>	30
CDLK42-90 /9 SWPC	<b>10 045.21</b>	CDLKF42-90 /9 SWSC	<b>10 370.50</b>	37
CDLK42-100/10-2SWPC	<b>10 513.30</b>	CDLKF42-100/10-2SWSC	<b>10 838.59</b>	37
CDLK42-100/10 SWPC	<b>10 513.30</b>	CDLKF42-100/10 SWSC	<b>10 838.59</b>	37
CDLK42-110/11-2SWPC	<b>13 983.81</b>	CDLKF42-110/11-2SWSC	<b>14 309.11</b>	45
CDLK42-110/11 SWPC	<b>13 983.81</b>	CDLKF42-110/11 SWSC	<b>14 309.11</b>	45
CDLK42-120/12-2SWPC	<b>14 353.17</b>	CDLKF42-120/12-2SWSC	<b>14 678.46</b>	45

<b>CDLK42-120 /12SWPC</b>	<b>14 353.17</b>	<b>CDLKF42-120 /12SWSC</b>	<b>14 678.46</b>	<b>45</b>
<b>CDLK42-130/13-2SWPC</b>	<b>14 719.55</b>	<b>CDLKF42-130/13-2SWSC</b>	<b>15 044.84</b>	<b>45</b>



[www.aikonrussia.ru](http://www.aikonrussia.ru)  
[www.cnpussia.ru](http://www.cnpussia.ru)

## CHL,CHLF(T) горизонтальные многоступенчатые центробежные насосы

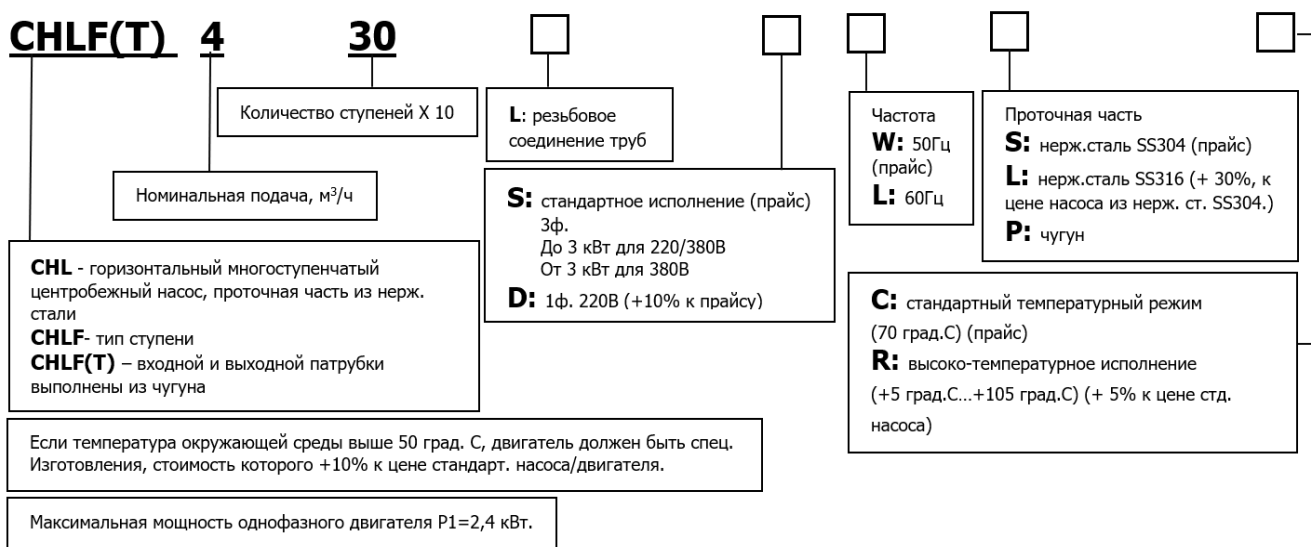

**обновление  
15.02.2023**

### Горизонтальные многоступенчатые центробежные насосы CHL 2 - 20

Проточн.часть -нерж. SS304		Мощность (кВт)
Артикул	Цена розница (USD) с НДС	
CHL 2-10LSWSC	243.17	0.37
CHL 2-20LSWSC	282.31	0.37
CHL 2-30LSWSC	293.49	0.37
CHL 2-40LSWSC	345.19	0.55
CHL 2-50LSWSC	415.07	0.55
CHL 2-60LSWSC	426.25	0.75

Проточн.часть -нерж. SS304		Мощность (кВт)
Артикул	Цена розница (USD) с НДС	
CHL 4-10LSWSC	287.90	0.37
CHL 4-20LSWSC	290.69	0.37
CHL 4-30LSWSC	325.63	0.55
CHL 4-40LSWSC	396.90	0.75



Проточн.часть -нерж. SS304		Мощность (кВт)
Артикул	Цена розница (USD) с НДС	
CHL 8-10LSWSC	<b>621.91</b>	0.75
CHL 8-20LSWSC	<b>647.07</b>	0.75
CHL 8-30LSWSC	<b>697.38</b>	1.1
CHL 8-40LSWSC	<b>728.12</b>	1.5
CHL 8-50LSWSC	<b>863.69</b>	2.2

Проточн.часть -нерж. SS304		Мощность (кВт)
Артикул	Цена розница (USD) с НДС	
CHL 15-10LSWSC	<b>780.53</b>	1.1
CHL 15-20LSWSC	<b>847.66</b>	2.2
CHL 15-30LSWSC	<b>1034.81</b>	3

Проточн.часть -нерж. SS304		Мощность (кВт)
Артикул	Цена розница (USD) с НДС	
CHL12-10LSWSC	<b>658.25</b>	0.75
CHL12-20LSWSC	<b>698.78</b>	1.2
CHL12-30LSWSC	<b>874.87</b>	1.8
CHL12-40LSWSC	<b>960.12</b>	2.4
CHL12-50LSWSC	<b>1127.82</b>	3

Проточн.часть -нерж. SS304		Мощность (кВт)
Артикул	Цена розница (USD) с НДС	
CHL20-10LSWSC	<b>804.99</b>	1.1
CHL20-20LSWSC	<b>886.05</b>	2.2
CHL20-30LSWSC	<b>1242.42</b>	4



### Горизонтальные многоступенчатые центробежные насосы CHLF(T) 2 - 20

CHLF патрубки - нерж. SS304		CHLF(T) патрубки - чугун		Мощность (кВт)
Артикул	Цена розница (USD) с НДС	Артикул	Цена розница (USD) с НДС	
CHLF2-20LSWSC	251.76	CHLFT2-20LSWPC	232.81	0.37
CHLF2-30LSWSC	274.77	CHLFT2-30LSWPC	244.99	0.37
CHLF2-40LSWSC	308.61	CHLFT2-40LSWPC	284.25	0.55
CHLF2-50LSWSC	408.77	CHLFT2-50LSWPC	372.23	0.55
CHLF2-60LSWSC	418.25	CHLFT2-60LSWPC	383.06	0.75

CHLF патрубки - нерж. SS304		CHLF(T) патрубки - чугун		Мощность (кВт)
Артикул	Цена розница (USD) с НДС	Артикул	Цена розница (USD) с НДС	
CHLF4-20LSWSC	273.42	CHLFT4-20LSWPC	257.18	0.37
CHLF4-30LSWSC	358.69	CHLFT4-30LSWPC	315.38	0.55
CHLF4-40LSWSC	374.94	CHLFT4-40LSWPC	341.10	0.75
CHLF4-50LSWSC	441.26	CHLFT4-50LSWPC	429.08	1.1
CHLF4-60LSWSC	460.21	CHLFT4-60LSWPC	452.09	1.1

CHLF патрубки - нерж. SS304		CHLF(T) патрубки - чугун		Мощность (кВт)
Артикул	Цена розница (USD) с НДС	Артикул	Цена розница (USD) с НДС	
CHLF8-10LSWSC	640.23	CHLFT8-10LSWPC	533.30	0.75
CHLF8-20LSWSC	665.95	CHLFT8-20LSWPC	560.37	0.75
CHLF8-30LSWSC	718.74	CHLFT8-30LSWPC	613.16	1.1
CHLF8-40LSWSC	812.14	CHLFT8-40LSWPC	706.56	1.5
CHLF8-50LSWSC	889.29	CHLFT8-50LSWPC	783.71	2.2

<b>CHLF патрубки -нерж. SS304</b>		<b>CHLF(T) патрубки - чугуn</b>		<b>Мощность (кВт)</b>
<b>Артикул</b>	<b>Цена розница (USD) с НДС</b>	<b>Артикул</b>	<b>Цена розница (USD) с НДС</b>	
CHLF12-10LSWSC	<b>651.06</b>	CHLFT12-10LSWPC	<b>544.13</b>	0.75
CHLF12-20LSWSC	<b>705.20</b>	CHLFT12-20LSWPC	<b>596.92</b>	1.2
CHLF12-30LSWSC	<b>925.83</b>	CHLFT12-30LSWPC	<b>820.26</b>	1.8
CHLF12-40LSWSC	<b>1027.35</b>	CHLFT12-40LSWPC	<b>920.42</b>	2.4
CHLF12-50LSWSC	<b>1231.74</b>	CHLFT12-50LSWPC	<b>1126.16</b>	3

<b>CHLF патрубки -нерж. SS304</b>		<b>CHLF(T) патрубки - чугуn</b>		<b>Мощность (кВт)</b>
<b>Артикул</b>	<b>Цена розница (USD) с НДС</b>	<b>Артикул</b>	<b>Цена розница (USD) с НДС</b>	
CHLF15-10LSWSC	<b>833.90</b>	CHLFT15-10LSWPC	<b>727.22</b>	1.1
CHLF15-20LSWSC	<b>875.75</b>	CHLFT15-20LSWPC	<b>769.06</b>	2.2
CHLF15-30LSWSC	<b>1068.76</b>	CHLFT15-30LSWPC	<b>961.70</b>	3
CHLF15-40LSWSC	<b>1301.00</b>	CHLFT15-40LSWPC	<b>1194.29</b>	4

<b>CHLF патрубки -нерж. SS304</b>		<b>CHLF(T) патрубки - чугуn</b>		<b>Мощность (кВт)</b>
<b>Артикул</b>	<b>Цена розница (USD) с НДС</b>	<b>Артикул</b>	<b>Цена розница (USD) с НДС</b>	
CHLF20-10LSWSC	<b>878.46</b>	CHLFT20-10LSWPC	<b>771.53</b>	1.1
CHLF20-20LSWSC	<b>915.01</b>	CHLFT20-20LSWPC	<b>806.72</b>	2.2
CHLF20-30LSWSC	<b>1206.02</b>	CHLFT20-30LSWPC	<b>1099.09</b>	4
CHLF20-40LSWSC	<b>1436.13</b>	CHLFT20-40LSWPC	<b>1329.20</b>	4.4



## СНМ горизонтальные многоступенчатые центробежные насосы

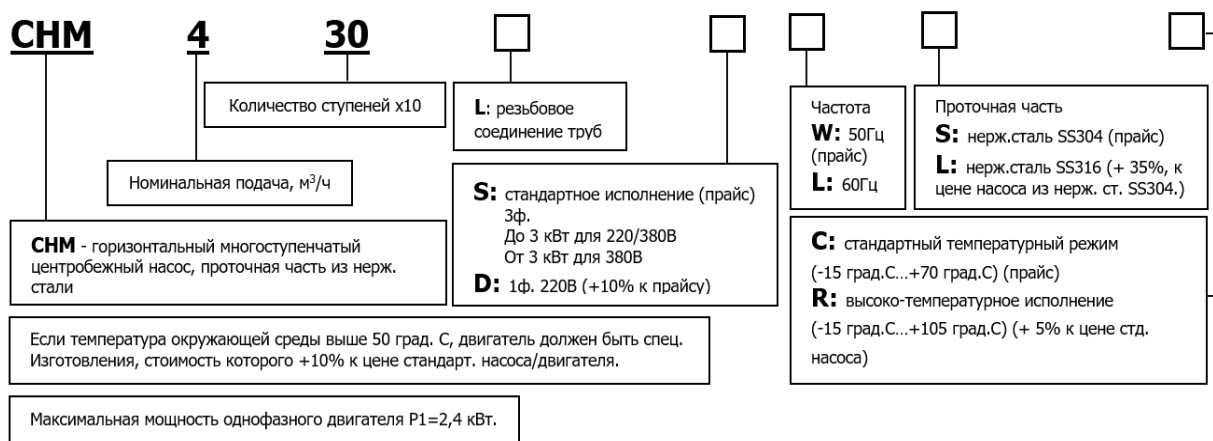

обновление  
15.02.2023

### Горизонтальные многоступенчатые центробежные насосы СНМ 1 - 20

Модель/Артикул	Мощность (кВт)	Цена розница (USD) с НДС
СНМ1-20LSWSC	0.37	310.43
СНМ1-30LSWSC	0.37	317.15
СНМ1-40LSWSC	0.37	333.71
СНМ1-50LSWSC	0.37	348.49
СНМ1-60LSWSC	0.37	387.01
СНМ1-70LSWSC	0.37	498.55
СНМ1-80LSWSC	0.55	549.16
СНМ1-90LSWSC	0.55	570.23

Модель/Артикул	Мощность (кВт)	Цена розница (USD) с НДС
СНМ3-20LSWSC	0.37	388.82
СНМ3-30LSWSC	0.37	396.85
СНМ3-40LSWSC	0.37	443.90
СНМ3-50LSWSC	0.55	495.43
СНМ3-60LSWSC	0.55	515.11
СНМ3-70LSWSC	0.75	573.35
СНМ3-80LSWSC	0.75	593.50
СНМ3-90LSWSC	1.1	684.90

Модель/Артикул	Мощность (кВт)	Цена розница (USD) с НДС
СНМ5-20LSWSC	0.37	382.99
СНМ5-30LSWSC	0.55	444.79
СНМ5-40LSWSC	0.55	481.96
СНМ5-50LSWSC	0.75	540.20

Модель/Артикул	Мощность (кВт)	Цена розница (USD) с НДС
СНМ10-10LSWSC	0.75	721.61
СНМ10-20LSWSC	0.75	729.24
СНМ10-30LSWSC	1.1	800.92
СНМ10-40LSWSC	1.5	899.46

CHM5-60LSWSC	1.1	<b>632.91</b>
CHM5-70LSWSC	1.1	<b>664.72</b>
CHM5-80LSWSC	1.1	<b>689.80</b>

CHM10-50LSWSC	2.2	<b>971.13</b>
CHM10-60LSWSC	2.2	<b>1065.62</b>
CHM10-70LSWSC	3	<b>1374.70</b>
CHM10-80LSWSC	3	<b>1412.79</b>
CHM10-90LSWSC	4	<b>1608.52</b>

Модель/Артикул	Мощность (кВт)	Цена розница (USD) с НДС
CHM15-10LSWSC	1.1	<b>924.97</b>
CHM15-20LSWSC	2.2	<b>1154.77</b>
CHM15-30LSWSC	3	<b>1433.83</b>
CHM15-40LSWSC	4	<b>1551.63</b>
CHM15-50LSWSC	4	<b>1598.68</b>
CHM15-60LSWSC	4.8	<b>1733.49</b>

Модель/Артикул	Мощность (кВт)	Цена розница (USD) с НДС
CHM20-10LSWSC	1.1	<b>886.02</b>
CHM20-20LSWSC	2.2	<b>1160.60</b>
CHM20-30LSWSC	4	<b>1670.35</b>
CHM20-40LSWSC	4.8	<b>1788.61</b>
CHM20-50LSWSC	5.5	<b>1879.51</b>
CHM20-60LSWSC	7.5	<b>1978.08</b>



## НСМ однонасосные установки повышения давления

**обновление**  
**15.02.2023**

Модель установки	Мощность, кВт	Модель контроллера		Цена розница (USD) с НДС	
		Локальное управление PD SS	Управление несколькими насосами PD ES	Модель с PD SS	Модель с PD ES
HCM2-2CPFH	0.37	PD SS 0,75	PD ES IP65 1,5	<b>818.45</b>	<b>1116.05</b>
HCM2-3CPFH	0.37	PD SS 0,75	PD ES IP65 1,5	<b>833.17</b>	<b>1130.77</b>
HCM2-4CPFH	0.55	PD SS 0,75	PD ES IP65 1,5	<b>870.64</b>	<b>1168.24</b>
HCM2-5CPFH	0.55	PD SS 0,75	PD ES IP65 1,5	<b>914.14</b>	<b>1211.74</b>
HCM2-6CPFH	0.75	PD SS 0,75	PD ES IP65 1,5	<b>929.53</b>	<b>1227.13</b>
HCMF(T)2-7CPFH	1.1	PD SS 1,5	--	<b>1085.57</b>	--
HCM4-2CPFH	0.37	PD SS 0,75	PD ES IP65 1,5	<b>825.14</b>	<b>1122.74</b>
HCM4-3CPFH	0.55	PD SS 0,75	PD ES IP65 1,5	<b>864.62</b>	<b>1162.22</b>
HCM4-4CPFH	0.75	PD SS 0,75	PD ES IP65 1,5	<b>911.46</b>	<b>1209.06</b>
HCMF(T)4-6CPFH	1,3	PD SS 1,5	--	<b>1093.11</b>	--
HCM8-2CPFH	0.75	PD SS 0,75	PD ES IP65 1,5	<b>1030.57</b>	<b>1328.17</b>
HCM8-3CPFH	1.1	PD SS 1,5	PD ES IP65 1,5	<b>1151.59</b>	<b>1441.93</b>
HCM8-4CPFH	1.5	PD SS 1,5	PD ES IP65 1,5	<b>1227.21</b>	<b>1517.55</b>
HCM8-5CPFH	2.2	PD SS 2,2	PD ES IP65 2,2	<b>1310.24</b>	<b>1605.18</b>
HCM12-2CPFH	1.2	PD SS 1,5	PD ES IP65 1,5	<b>1194.42</b>	<b>1484.76</b>
HCM12-3CPFH	1.8	PD SS 2,2	PD ES IP65 2,2	<b>1260.05</b>	<b>1554.99</b>
HCM16-2CPFH	2.2	PD SS 2,2	PD ES IP65 2,2	<b>1235.29</b>	<b>1530.23</b>
HCM20-2CPFH	2.2	PD SS 2,2	PD ES IP65 2,2	<b>1342.36</b>	<b>1637.30</b>



**TD одноступенчатые циркуляционные насосы типа "ин-лайн"**

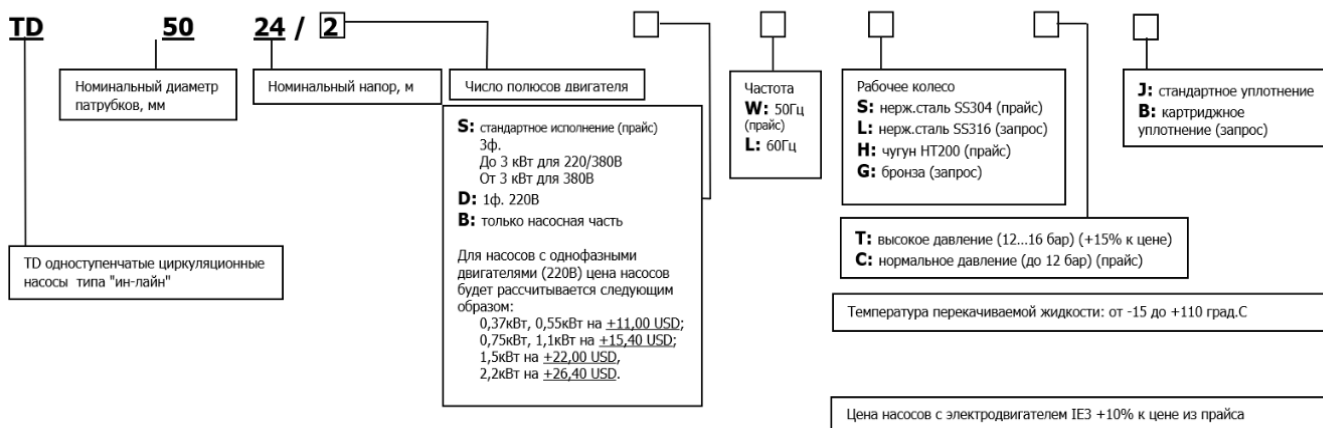

обновление 15.02.2023

Примечание: в моделях насосов TD32-6(I), TD32-10(I), TD50-6(I), TD50-11(I) рабочее колесо выполнено из нержавеющей стали SS304, для остальных элементов материал изготовления чугун HT200; в остальных моделях с пометкой (I) вся проточная часть выполнена из нержавеющей стали SS304.

**Одноступенчатые циркуляционные насосы TD 32-65**

Старая модель	Новая модель	Мощность (кВт)	рабоч.колесо нерж.ст. SS304		рабоч.колесо -чугун HT200	
			Артикул	Цена розница (USD) с НДС	Артикул	Цена розница (USD) с НДС
<b>Одноступенчатые циркуляционные насосы TD 32-65</b>						
TD32-6(I)/2		0.25	TD32-6(I)/2SWSCJ	451.41	<b>Рабочее колесо - нерж. сталь SS304, корпус - чугун</b>	
TD32-10(I)/2		0.37	TD32-10(I)/2SWSCJ	591.16		
TD50-6(I)/2		0.37	TD50-6(I)/2SWSCJ	661.04		
TD50-11(I)/2		0.75	TD50-11(I)/2SWSCJ	732.32		
	<b>TD32-12.5(I)/2</b>	0.75	TD32-12.5(I)/2SWSCJ	1466.63	<b>Вся проточная часть из нержавеющей стали</b>	
	<b>TD32-15(I)/2</b>	1.1	TD32-15(I)/2SWSCJ	1470.87		
	<b>TD40-8(I)/2</b>	0.75	TD40-8(I)/2SWSCJ	1538.60		
	<b>TD40-12.5(I)/2</b>	1.1	TD40-12.5(I)/2SWSCJ	1544.27		
	<b>TD40-15(I)/2</b>	1.5	TD40-15(I)/2SWSCJ	1650.76		
	<b>TD50-8(I)/2</b>	1.1	TD50-8(I)/2SWSCJ	1602.77		
	<b>TD50-12.5(I)/2</b>	1.5	TD50-12.5(I)/2SWSCJ	1691.66		
	<b>TD65-8(I)/2</b>	1.1	TD65-8(I)/2SWSCJ	1712.15		
	<b>TD65-12.5(I)/2</b>	1.5	TD65-12.5(I)/2SWSCJ	1822.17		
	<b>TD65-15(I)/2</b>	2.2	TD65-15(I)/2SWSCJ	1875.08		
	<b>TD80-8(I)/2</b>	1.5	TD80-8(I)/2SWSCJ	2004.20		
	<b>TD80-12.5(I)/2</b>	2.2	TD80-12.5(I)/2SWSCJ	2057.11		
	<b>TD80-15(I)/2</b>	3	TD80-15(I)/2SWSCJ	2230.66		



TD32-14/2	<b>TD32-14G/2</b>	0.75	TD32-14G/2SWSCJ	<b>740.70</b>	TD32-14G/2SWHCJ	<b>665.23</b>
TD32-18/2	<b>TD32-18G/2</b>	1.1	TD32-18G/2SWSCJ	<b>740.70</b>	TD32-18G/2SWHCJ	<b>665.23</b>
TD32-21/2	<b>TD32-21G/2</b>	1.5	TD32-21G/2SWSCJ	<b>821.76</b>	TD32-21G/2SWHCJ	<b>742.10</b>
TD32-25/2	<b>TD32-26G/2</b>	2.2	TD32-26G/2SWSCJ	<b>866.48</b>	TD32-26G/2SWHCJ	<b>785.42</b>
TD32-32/2	<b>TD32-33G/2</b>	3	TD32-33G/2SWSCJ	<b>1021.61</b>	TD32-33G/2SWHCJ	<b>933.56</b>
TD32-38/2	<b>TD32-40G/2</b>	4	TD32-40G/2SWSCJ	<b>1253.60</b>	TD32-40G/2SWHCJ	<b>1123.63</b>
TD32-50/2	<b>TD32-50G/2</b>	5.5	TD32-50G/2SWSCJ	<b>1589.01</b>	TD32-50G/2SWHCJ	<b>1442.27</b>
	<b>TD40-14G/2</b>	0.75	TD40-14G/2SWSCJ	<b>666.82</b>	TD40-14G/2SWHCJ	<b>604.16</b>
TD40-16/2	<b>TD40-16G/2</b>	1.1	TD40-16G/2SWSCJ	<b>666.63</b>	TD40-16G/2SWHCJ	<b>605.14</b>
TD40-20/2	<b>TD40-21G/2</b>	1.5	TD40-21G/2SWSCJ	<b>746.29</b>	TD40-21G/2SWHCJ	<b>679.21</b>
TD40-18/2	<b>TD40-20G/2</b>	2.2	TD40-20G/2SWSCJ	<b>832.94</b>	TD40-20G/2SWHCJ	<b>758.87</b>
TD40-25/2	<b>TD40-26G/2</b>	3	TD40-26G/2SWSCJ	<b>1050.96</b>	TD40-26G/2SWHCJ	<b>934.96</b>
TD40-30/2	<b>TD40-30G/2</b>	4	TD40-30G/2SWSCJ	<b>1199.10</b>	TD40-30G/2SWHCJ	<b>1076.11</b>
TD40-36/2	<b>TD40-36G/2</b>	5.5	TD40-36G/2SWSCJ	<b>1605.78</b>	TD40-36G/2SWHCJ	<b>1452.05</b>
TD40-48/2	<b>TD40-48G/2</b>	7.5	TD40-48G/2SWSCJ	<b>1644.92</b>	TD40-48G/2SWHCJ	<b>1495.38</b>
	<b>TD50-12G/2</b>	1.1	TD50-12G/2SWSCJ	<b>778.44</b>	TD50-12G/2SWHCJ	<b>702.97</b>
TD50-15/2	<b>TD50-15G/2</b>	1.5	TD50-15G/2SWSCJ	<b>862.29</b>	TD50-15G/2SWHCJ	<b>782.63</b>
TD50-18/2	<b>TD50-18G/2</b>	2.2	TD50-18G/2SWSCJ	<b>907.01</b>	TD50-18G/2SWHCJ	<b>825.95</b>
TD50-24/2	<b>TD50-24G/2</b>	3	TD50-24G/2SWSCJ	<b>1062.14</b>	TD50-24G/2SWHCJ	<b>975.49</b>
TD50-28/2	<b>TD50-28G/2</b>	4	TD50-28G/2SWSCJ	<b>1228.45</b>	TD50-28G/2SWHCJ	<b>1120.84</b>
TD50-32/2	<b>TD50-32G/2</b>	3	TD50-32G/2SWSCJ	<b>1147.36</b>	TD50-32G/2SWHCJ	<b>1026.53</b>
TD50-38/2	<b>TD50-39G/2</b>	4	TD50-39G/2SWSCJ	<b>1306.19</b>	TD50-39G/2SWHCJ	<b>1181.63</b>
TD50-48/2	<b>TD50-49G/2</b>	5.5	TD50-49G/2SWSCJ	<b>1623.87</b>	TD50-49G/2SWHCJ	<b>1501.15</b>
TD50-58/2	<b>TD50-59G/2</b>	7.5	TD50-59G/2SWSCJ	<b>1845.62</b>	TD50-59G/2SWHCJ	<b>1657.52</b>
TD50-80/2	<b>TD50-80G/2</b>	11	TD50-80G/2SWSCJ	<b>2450.43</b>	TD50-80G/2SWHCJ	<b>2243.66</b>
TD50-35/2	<b>TD50-35G/2</b>	5.5	TD50-35G/2SWSCJ	<b>1535.91</b>	TD50-35G/2SWHCJ	<b>1417.12</b>
TD50-40/2	<b>TD50-40G/2</b>	7.5	TD50-40G/2SWSCJ	<b>1767.90</b>	TD50-40G/2SWHCJ	<b>1575.04</b>
TD50-50/2	<b>TD50-50G/2</b>	11	TD50-50G/2SWSCJ	<b>2357.67</b>	TD50-50G/2SWHCJ	<b>2138.25</b>
TD50-60/2	<b>TD50-60G/2</b>	15	TD50-60G/2SWSCJ	<b>2528.17</b>	TD50-60G/2SWHCJ	<b>2300.37</b>
TD50-70/2	<b>TD50-70G/2</b>	18.5	TD50-70G/2SWSCJ	<b>2691.68</b>	TD50-70G/2SWHCJ	<b>2423.35</b>
TD50-81/2	<b>TD50-81G/2</b>	22	TD50-81G/2SWSCJ	<b>3215.76</b>	TD50-81G/2SWHCJ	<b>2925.07</b>
	<b>TD65-15G/2</b>	2.2	TD65-15G/2SWSCJ	<b>958.72</b>	TD65-15G/2SWHCJ	<b>842.72</b>
TD65-19/2	<b>TD65-20G/2</b>	3	TD65-20G/2SWSCJ	<b>1116.64</b>	TD65-20G/2SWHCJ	<b>992.26</b>
TD65-22/2	<b>TD65-22G/2</b>	4	TD65-22G/2SWSCJ	<b>1266.18</b>	TD65-22G/2SWHCJ	<b>1136.21</b>
TD65-30/2	<b>TD65-30G/2</b>	5.5	TD65-30G/2SWSCJ	<b>1575.04</b>	TD65-30G/2SWHCJ	<b>1431.09</b>
TD65-36/2	<b>TD65-37G/2</b>	5.5	TD65-37G/2SWSCJ	<b>1653.13</b>	TD65-37G/2SWHCJ	<b>1516.74</b>
TD65-34/2	<b>TD65-34G/2</b>	7.5	TD65-34G/2SWSCJ	<b>1614.17</b>	TD65-34G/2SWHCJ	<b>1467.43</b>
TD65-40/2	<b>TD65-41G/2</b>	11	TD65-41G/2SWSCJ	<b>2380.03</b>	TD65-41G/2SWHCJ	<b>2153.62</b>
TD65-48/2	<b>TD65-48G/2</b>	7.5	TD65-48G/2SWSCJ	<b>1694.87</b>	TD65-48G/2SWHCJ	<b>1553.48</b>
TD65-50/2	<b>TD65-51G/2</b>	15	TD65-51G/2SWSCJ	<b>2544.94</b>	TD65-51G/2SWHCJ	<b>2312.95</b>
TD65-61/2	<b>TD65-61G/2</b>	18.5	TD65-61G/2SWSCJ	<b>2676.31</b>	TD65-61G/2SWHCJ	<b>2438.72</b>
TD65-67/2	<b>TD65-68G/2</b>	22	TD65-68G/2SWSCJ	<b>3243.71</b>	TD65-68G/2SWHCJ	<b>2950.23</b>
TD65-83/2	<b>TD65-85G/2</b>	30	TD65-85G/2SWSCJ	<b>4224.79</b>	TD65-85G/2SWHCJ	<b>3882.39</b>

### Одноступенчатые циркуляционные насосы TD 80-150

Старая модель	Новая модель	Мощность (кВт)	рабоч.колесо нерж.ст. SS304		рабоч.колесо -чугун HT200	
			Артикул	Цена розница (USD) с НДС	Артикул	Цена розница (USD) с НДС
TD80-13/2	<b>TD80-13G/2</b>	3	TD80-13G/2SWSCJ	<b>1179.53</b>	TD80-13G/2SWHCJ	<b>1057.95</b>
TD80-18/2	<b>TD80-18G/2</b>	4	TD80-18G/2SWSCJ	<b>1327.67</b>	TD80-18G/2SWHCJ	<b>1200.50</b>
TD80-22/2	<b>TD80-23G/2</b>	5.5	TD80-23G/2SWSCJ	<b>1639.33</b>	TD80-23G/2SWHCJ	<b>1498.17</b>
TD80-28/2	<b>TD80-29G/2</b>	7.5	TD80-29G/2SWSCJ	<b>1678.46</b>	TD80-29G/2SWHCJ	<b>1534.51</b>
TD80-30/2	<b>TD80-32G/2</b>	11	TD80-32G/2SWSCJ	<b>2463.88</b>	TD80-32G/2SWHCJ	<b>2216.51</b>



TD80-38/2	<b>TD80-38G/2</b>	15	TD80-38G/2SWSCJ	<b>2627.39</b>	TD80-38G/2SWHCJ	<b>2373.04</b>
TD80-40/2	<b>TD80-41G/2</b>	11	TD80-41G/2 SWSCJ	<b>2328.32</b>	TD80-41G/2 SWHCJ	<b>2171.79</b>
TD80-48/2	<b>TD80-48G/2</b>	15	TD80-48G/2 SWSCJ	<b>2501.61</b>	TD80-48G/2 SWHCJ	<b>2338.10</b>
TD80-47/2	<b>TD80-47G/2</b>	18.5	TD80-47G/2SWSCJ	<b>2760.16</b>	TD80-47G/2SWHCJ	<b>2497.42</b>
TD80-54/2	<b>TD80-54G/2</b>	22	TD80-54G/2SWSCJ	<b>3282.84</b>	TD80-54G/2SWHCJ	<b>2999.14</b>
TD80-67/2	<b>TD80-67G/2</b>	30	TD80-67G/2SWSCJ	<b>4261.13</b>	TD80-67G/2SWHCJ	<b>3929.91</b>
TD100-9/2	не изм.	2.2	TD100-9/2SWSCJ	<b>936.36</b>	TD100-9/2SWHCJ	<b>869.28</b>
TD100-15/2		4	TD100-15/2SWSCJ	<b>1236.83</b>	TD100-15/2SWHCJ	<b>1157.17</b>
TD100-17/2	<b>TD100-17G/2</b>	5.5	TD100-17G/2SWSCJ	<b>1691.04</b>	TD100-17G/2SWHCJ	<b>1556.87</b>
TD100-22/2	<b>TD100-22G/2</b>	7.5	TD100-22G/2SWSCJ	<b>1730.17</b>	TD100-22G/2SWHCJ	<b>1596.00</b>
TD100-27/2	не изм.	11	TD100-27/2 SWSCJ	<b>2448.51</b>	TD100-27/2 SWHCJ	<b>2272.42</b>
TD100-33/2		15	TD100-33/2 SWSCJ	<b>2669.32</b>	TD100-33/2 SWHCJ	<b>2438.72</b>
TD100-40/2	<b>TD100-40G/2</b>	18.5	TD100-40G/2SWSCJ	<b>2796.50</b>	TD100-40G/2SWHCJ	<b>2553.32</b>
TD100-48/2	<b>TD100-48G/2</b>	22	TD100-48G/2SWSCJ	<b>3321.98</b>	TD100-48G/2SWHCJ	<b>3053.65</b>
TD100-52/2	<b>TD100-52G/2</b>	30	TD100-52G/2SWSCJ	<b>4266.72</b>	TD100-52G/2SWHCJ	<b>3956.46</b>
TD125-11/4	<b>TD125-11G/4</b>	5.5	TD125-11G/4SWSCJ	<b>2361.86</b>	TD125-11G/4SWHCJ	<b>2106.11</b>
TD125-14/4	<b>TD125-14G/4</b>	7.5	TD125-14G/4SWSCJ	<b>2433.13</b>	TD125-14G/4SWHCJ	<b>2175.99</b>
TD125-18/4	<b>TD125-19G/4</b>	11	TD125-19G/4 SWSCJ	<b>3217.16</b>	TD125-19G/4 SWHCJ	<b>3137.50</b>
TD125-22/4	<b>TD125-22G/4</b>	15	TD125-22G/4 SWSCJ	<b>4054.29</b>	TD125-22G/4 SWHCJ	<b>3549.78</b>
TD125-28/4	<b>TD125-28G/4</b>	18.5	TD125-28G/4 SWSCJ	<b>4551.82</b>	TD125-28G/4 SWHCJ	<b>4023.55</b>
TD125-32/4	<b>TD125-32G/4</b>	22	TD125-32G/4 SWSCJ	<b>4711.14</b>	TD125-32G/4 SWHCJ	<b>4175.88</b>
TD125-40/4	<b>TD125-40G/4</b>	30	TD125-40G/4SWSCJ	<b>5639.11</b>	TD125-40G/4SWHCJ	<b>5061.93</b>
TD125-48/4	<b>TD125-48G/4</b>	37	TD125-48G/4SWSCJ	<b>6124.06</b>	TD125-48G/4SWHCJ	<b>5942.38</b>
TD150-12.5/4	<b>TD150-12.5G/4</b>	11	TD150-12.5G/4 SWSCJ	<b>4628.49</b>	TD150-12.5G/4 SWHCJ	<b>4458.47</b>
TD150-17/4	<b>TD150-17G/4</b>	15	TD150-17G/4 SWSCJ	<b>4845.79</b>	TD150-17G/4 SWHCJ	<b>4676.48</b>
TD150-21/4	<b>TD150-22G/4</b>	18.5	TD150-22G/4 SWSCJ	<b>5403.07</b>	TD150-22G/4 SWHCJ	<b>5233.76</b>
TD150-25/4	не изм.	22	TD150-25/4SWSCJ	<b>5784.72</b>	TD150-25/4SWHCJ	<b>5539.95</b>
TD150-33/4		30	TD150-33/4SWSCJ	<b>6971.99</b>	TD150-33/4SWHCJ	<b>6727.93</b>
TD150-40/4		37	TD150-40/4SWSCJ	<b>8071.11</b>	TD150-40/4SWHCJ	<b>7710.61</b>
TD150-50/4		45	TD150-50/4SWSCJ	<b>9394.55</b>	TD150-50/4SWHCJ	<b>9033.34</b>

### Одноступенчатые циркуляционные насосы TD 200-350

Старая модель	Новая модель	Мощность (кВт)	рабоч.колесо -нерж.ст.SS304		рабоч.колесо -чугун HT200	
			Артикул	Цена розница (USD) с НДС	Артикул	Цена розница (USD) с НДС
TD200-16/4	не изм.	18.5	TD200-16/4SWSCB	<b>5905.60</b>	TD200-16/4SWHCB	<b>5507.57</b>
TD200-19/4		22	TD200-19/4SWSCB	<b>5994.05</b>	TD200-19/4SWHCB	<b>5596.01</b>
TD200-24/4		30	TD200-24/4SWSCB	<b>7355.31</b>	TD200-24/4SWHCB	<b>6947.22</b>
TD200-31/4		37	TD200-31/4SWSCB	<b>8043.98</b>	TD200-31/4SWHCB	<b>7555.65</b>
TD200-36/4		45	TD200-36/4SWSCB	<b>9302.20</b>	TD200-36/4SWHCB	<b>8636.36</b>
TD200-47/4		55	TD200-47/4SWSCB	по запросу	TD200-47/4SWHCB	по запросу
TD200-53/4		75	TD200-53/4SWSCB		TD200-53/4SWHCB	
TD200-12.5/4		22	TD200-12.5/4SWSCB	<b>5987.10</b>	TD200-12.5/4SWHCB	<b>5588.80</b>
TD200-20/4		30	TD200-20/4SWSCB	<b>6926.26</b>	TD200-20/4SWHCB	<b>6527.96</b>
TD200-23/4		37	TD200-23/4SWSCB	<b>8034.51</b>	TD200-23/4SWHCB	<b>7546.77</b>
TD200-27/4		45	TD200-27/4SWSCB	<b>9290.91</b>	TD200-27/4SWHCB	<b>8625.68</b>
TD200-32/4		55	TD200-32/4SWSCB	по запросу	TD200-32/4SWHCB	по запросу
TD200-43/4		75	TD200-43/4SWSCB		TD200-43/4SWHCB	
TD200-50/4		90	TD200-50/4SWSCB		TD200-50/4SWHCB	
TD200-53/4		75	TD200-53/4SWSCB		TD200-53/4SWHCB	

Старая модель	Новая модель	Мощность (кВт)	рабоч.колесо -нерж.ст.SS304		рабоч.колесо -чугун HT200		
			Артикул	Цена розница (USD) с НДС	Артикул	Цена розница (USD) с НДС	
TD250-16/4	не изм.	30	TD250-16/4SWSCB	7967.36	TD250-16/4SWHCB	7299.63	
TD250-19/4		37	TD250-19/4SWSCB	8452.61	TD250-19/4SWHCB	7769.90	
TD250-22/4		45	TD250-22/4SWSCB	9745.71	TD250-22/4SWHCB	8939.71	
TD250-29/4		55	TD250-29/4SWSCB	по запросу	TD250-29/4SWHCB	по запросу	
TD250-36/4		75	TD250-36/4SWSCB		TD250-36/4SWHCB		
TD250-47/4		90	TD250-47/4SWSCB		TD250-47/4SWHCB		
TD250-56/4		110	TD250-56/4SWSCB		TD250-56/4SWHCB		
TD250-12.5/4		30	TD250-12.5/4SWSCB	7957.65	TD250-12.5/4SWHCB	7291.02	
TD250-14/4		37	TD250-14/4SWSCB	8442.60	TD250-14/4SWHCB	7760.60	
TD250-17/4		45	TD250-17/4SWSCB	9733.94	TD250-17/4SWHCB	8927.55	
TD250-20/4		55	TD250-20/4SWSCB	по запросу	TD250-20/4SWHCB	по запросу	
TD250-26/4		75	TD250-26/4SWSCB		TD250-26/4SWHCB		
TD250-32/4		90	TD250-32/4SWSCB		TD250-32/4SWHCB		
TD250-40/4		110	TD250-40/4SWSCB		TD250-40/4SWHCB		
TD250-50/4		132	TD250-50/4SWSCB		TD250-50/4SWHCB		
Старая модель		Новая модель	Мощность (кВт)	рабоч.колесо -нерж.ст.SS304		рабоч.колесо -чугун HT200	
				Артикул	Цена розница (USD) с НДС	Артикул	Цена розница (USD) с НДС
TD300-15/4	не изм.	55	---	---	TD300-15/4SWHCB	по запросу	
TD300-20/4		75	---	---	TD300-20/4SWHCB		
TD300-25/4		90	---	---	TD300-25/4SWHCB		
TD300-30/4		110	---	---	TD300-30/4SWHCB		
TD300-35/4		132	---	---	TD300-35/4SWHCB		
TD300-44/4		160	---	---	TD300-44/4SWHCB		
TD300-55/4		200	---	---	TD300-55/4SWHCB		
Старая модель	Новая модель	Мощность (кВт)	рабоч.колесо -нерж.ст.SS304		рабоч.колесо -чугун HT200		
			Артикул	Цена розница (USD) с НДС	Артикул	Цена розница (USD) с НДС	
TD300-15(l)/4	не изм.	45	TD300-15(l)/4SWSCB	12619.88	---	---	
TD300-18(l)/4		55	TD300-18(l)/4SWSCB	по запросу	---	---	
TD300-21(l)/4		75	TD300-21(l)/4SWSCB		---	---	
TD300-30(l)/4		90	TD300-30(l)/4SWSCB		---	---	
TD300-36(l)/4		110	TD300-36(l)/4SWSCB		---	---	
TD350-18(l)/4		75	TD350-18(l)/4SWSCB		---	---	
TD350-20(l)/4		90	TD350-20(l)/4SWSCB		---	---	
TD350-23(l)/4		110	TD350-23(l)/4SWSCB		---	---	

Насосные агрегаты комплектуются двигателями с классом защиты IP55 в стандартном исполнении (по цене агрегата с двигателем IP54)!!!



## Циркуляционные насосы с "мокрым ротором" CMS(L) Aikon

обновление  
15.02.2023

Модель/арт.	DN входного/выходного патрубка (фланец), мм	Напряжение, В	Максимальный расход, л/мин	Максимальный напор, м	Мощность, Вт	Цена розница (USD) с НДС
CMS(L)40-8-370F3S	40	3*380	145	8	370	430
CMS(L)40-13-550F3S	40		180	13	550	472
CMS(L)40-19-1000F3S	40		250	19	1000	944
CMS(L)50-14-1000F3S	50		450	14	1000	774
CMS(L)50-18-1300F3S	50		450	18	1300	944

## Циркуляционные насосы с "мокрым ротором" нового поколения CMS(L) Aikon

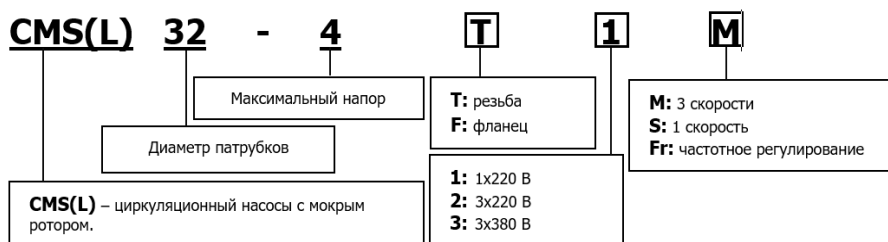

Для моделей с резьбовыми патрубками ответные присоединительные гайки входят в комплект поставки.

Модель/арт.	DN входного/выходного патрубка, мм /резьба	Напряжение, В	Максимальный расход, м3/ч	Максимальный напор, м	Мощность, Вт	Цена розница (USD) с НДС
CMS(L)25-4T1M 180мм	1½"-1"	220	3.00	4.00	65/50/32	75.43
CMS(L)32-4T1M	2" - 1¼" или 1½"	220	3.50	4.00	65/50/32	81.02
CMS(L)25-6T1M 180мм	1½"-1"	220	3.30	6.00	100/70/55	75.43
CMS(L)32-6T1M	2" - 1¼" или 1½"	220	4.00	6.00	100/70/55	81.02
CMS(L)25-8T1M	1½"-1"	220	6.00	8.00	245/190/135	158.43
CMS(L)32-8T1M	2" - 1¼" или 1½"	220	8.00	8.00	245/190/135	164.81
CMS(L)25-16T3M	1 1/4"-1" или 1 1/4"-3/4"	3x380	14.5/12/9.2	16/13/11	700/450/400	749.40
CMS(L)32-8F1M	DN32	220	8.00	8.00	245/190/135	213.25
CMS(L)32-12F1S	DN32	220	12.00	12.00	500	383.46
CMS(L)40-6F1S	DN40	220	22.00	6.00	500	414.31
CMS(L)40-12F3M	DN40	3x380	14/11.2/8	14.5/12.5/11	700/450/400	797.77
CMS(L)40-16F3M	DN40	3x380	17/14/12	16.2/15.5/14.5	1000/700/600	883.30
CMS(L)50-12F3M	DN50	3x380	24/18.5/13	13.2/11/10	1000/700/600	981.06
CMS(L)50-16F3M	DN50	3x380	28/26/24	16.5/16/15	1300/1000/900	1 154.69
CMS(L)65-12F3M	DN65	3x380	49/44/39	13.7/11/9.5	1300/1000/900	1 221.52
CMS(L)80-12F3M	DN80	3x380	41.23/35/33	12.22/10/9.3	1300/1000/900	1 248.41
CMS(L)25-4T1Fr	1½"	220	2.50	4.00	25	206.03

CMS(L)32-4T1Fr	2"	220	2.80	4.00	25	<b>208.13</b>
CMS(L)25-6T1Fr	1½"	220	3.20	6.00	39	<b>206.03</b>
CMS(L)32-6T1Fr	2"	220	3.60	6.00	39	<b>208.13</b>



## SJ многоступенчатые погружные насосы из нержавеющей стали

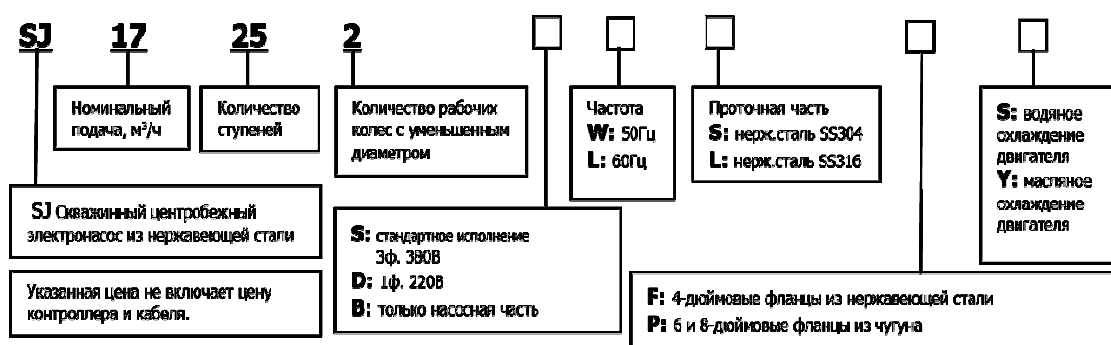

1. Цены в прайсе даны для насосов с двигателем **50Гц/ 380В** . Возможно исполнение насосов с однофазным и трехфазным двигателем.
2. Указанная цена не включает цену контроллера и кабеля.
3. Для всех типов насосов рабочее колесо изготовлено из **нержавеющей стали**.
5. Для насосов SJ с 4 дюймовым двигателем, материал крышки двигателя и основание из **меди**. Для двигателей из нержавеющей стали цены предоставляются по запросу.
6. Для насосов SJ с 6 и 8 дюймовым двигателем, материал крышки двигателя и основание **чугунные**. Для двигателей из нержавеющей стали цены по запросу.
7. Стоимость насоса SJ в исполнении из нерж.стали SS316 формируется как цена насоса из SS304 +60%.
8. С 01.09.2020г. Насосы с 4,6" двигателями СТАНДАРТНО поставляются маслозаполненными, с 8" и более - с водяным охлаждением двигателя.
- 9. ВАЖНО!!! Перед погружением агрегата с водяным охлаждением двигателя необходимо полностью заполнить электродвигатель дистиллированной водой (артикул с литерой S).**
10. Насосы SJ с 4" с маслозаполняемым двигателем могут быть изготовлены вертикального и горизонтального исполнения.
11. Стоимость насоса SJ в горизонтальном исполнении : SJ 1-12 типоразмеры +10%, SJ 17-200 типоразмеры +15% к цене насоса стандартного исполнения по прайс-листу

## Многоступенчатые погружные насосы из нержавеющей стали SJ 1

4 дюймовый двигатель		6 дюймовый двигатель		Мощность (кВт)
Артикул	Цена розница (USD) с НДС	Артикул	Цена розница (USD) с НДС	
SJ1-1SWSF4Y	497.04	----	-----	0.37
SJ1-2SWSF4Y	511.17	----	-----	0.37
SJ1-3SWSF4Y	525.32	----	-----	0.37
SJ1-4SWSF4Y	539.45	----	-----	0.37
SJ1-5SWSF4Y	553.59	----	-----	0.37
SJ1-6SWSF4Y	567.74	----	-----	0.37
SJ1-7SWSF4Y	582.26	----	-----	0.37
SJ1-8SWSF4Y	596.41	----	-----	0.37
SJ1-9SWSF4Y	610.54	----	-----	0.37
SJ1-10SWSF4Y	624.68	----	-----	0.55
SJ1-11SWSF4Y	638.83	----	-----	0.55
SJ1-12SWSF4Y	653.35	----	-----	0.55
SJ1-13SWSF4Y	668.24	----	-----	0.55
SJ1-14SWSF4Y	723.52	----	-----	0.75
SJ1-15SWSF4Y	737.65	----	-----	0.75
SJ1-16SWSF4Y	752.19	----	-----	0.75
SJ1-17SWSF4Y	766.32	----	-----	0.75
SJ1-18SWSF4Y	814.71	----	-----	1.1
SJ1-19SWSF4Y	830.34	----	-----	1.1
SJ1-20SWSF4Y	844.48	----	-----	1.1
SJ1-21SWSF4Y	859.01	----	-----	1.1
SJ1-22SWSF4Y	873.15	----	-----	1.1
SJ1-23SWSF4Y	887.28	----	-----	1.1
SJ1-24SWSF4Y	901.43	----	-----	1.1
SJ1-25SWSF4Y	915.57	----	-----	1.1
SJ1-26SWSF4Y	978.07	----	-----	1.5
SJ1-27SWSF4Y	992.22	----	-----	1.5
SJ1-28SWSF4Y	1 006.36	----	-----	1.5
SJ1-29SWSF4Y	1 020.49	----	-----	1.5
SJ1-30SWSF4Y	1 034.64	----	-----	1.5
SJ1-31SWSF4Y	1 049.16	----	-----	1.5
SJ1-32SWSF4Y	1 063.31	----	-----	1.5
SJ1-33SWSF4Y	1 082.97	----	-----	1.5
SJ1-34SWSF4Y	1 097.10	----	-----	1.5
SJ1-35SWSF4Y	1 111.24	----	-----	1.5
SJ1-36SWSF4Y	1 125.77	----	-----	1.5
SJ1-37SWSF4Y	1 249.52	----	-----	2.2
SJ1-38SWSF4Y	1 263.66	----	-----	2.2
SJ1-39SWSF4Y	1 277.80	----	-----	2.2
SJ1-40SWSF4Y	1 292.32	----	-----	2.2
SJ1-41SWSF4Y	1 306.46	----	-----	2.2

SJ1-42SWSF4Y	<b>1 320.60</b>	----	----	2.2
SJ1-43SWSF4Y	<b>1 334.74</b>	----	----	2.2
SJ1-44SWSF4Y	<b>1 352.51</b>	----	----	2.2
SJ1-45SWSF4Y	<b>1 367.04</b>	----	----	2.2
SJ1-46SWSF4Y	<b>1 381.19</b>	----	----	2.2
SJ1-47SWSF4Y	<b>1 395.33</b>	----	----	2.2
SJ1-48SWSF4Y	<b>1 409.46</b>	----	----	2.2
SJ1-49SWSF4Y	<b>1 423.61</b>	----	----	2.2
SJ1-50SWSF4Y	<b>1 438.13</b>	----	----	2.2

### Многоступенчатые погружные насосы из нержавеющей стали SJ 3

4 дюймовый двигатель		6 дюймовый двигатель		Мощность (кВт)
Артикул	Цена розница (USD) с НДС	Артикул	Цена розница (USD) с НДС	
SJ3-1SWSF4Y	<b>497.04</b>	----	----	0.37
SJ3-2SWSF4Y	<b>511.65</b>	----	----	0.37
SJ3-3SWSF4Y	<b>526.28</b>	----	----	0.37
SJ3-4SWSF4Y	<b>540.89</b>	----	----	0.37
SJ3-5SWSF4Y	<b>555.51</b>	----	----	0.37
SJ3-6SWSF4Y	<b>570.13</b>	----	----	0.37
SJ3-7SWSF4Y	<b>585.13</b>	----	----	0.55
SJ3-8SWSF4Y	<b>599.76</b>	----	----	0.55
SJ3-9SWSF4Y	<b>614.38</b>	----	----	0.55
SJ3-10SWSF4Y	<b>670.13</b>	----	----	0.75
SJ3-11SWSF4Y	<b>684.75</b>	----	----	0.75
SJ3-12SWSF4Y	<b>699.76</b>	----	----	0.75
SJ3-13SWSF4Y	<b>749.37</b>	----	----	1.1
SJ3-14SWSF4Y	<b>763.98</b>	----	----	1.1
SJ3-15SWSF4Y	<b>778.61</b>	----	----	1.1
SJ3-16SWSF4Y	<b>793.62</b>	----	----	1.1
SJ3-17SWSF4Y	<b>808.24</b>	----	----	1.1
SJ3-18SWSF4Y	<b>822.85</b>	----	----	1.1
SJ3-19SWSF4Y	<b>886.97</b>	----	----	1.5
SJ3-20SWSF4Y	<b>901.58</b>	----	----	1.5
SJ3-21SWSF4Y	<b>916.59</b>	----	----	1.5
SJ3-22SWSF4Y	<b>931.21</b>	----	----	1.5
SJ3-23SWSF4Y	<b>1 055.44</b>	----	----	2.2
SJ3-24SWSF4Y	<b>1 070.06</b>	----	----	2.2
SJ3-25SWSF4Y	<b>1 084.67</b>	----	----	2.2
SJ3-26SWSF4Y	<b>1 099.67</b>	----	----	2.2
SJ3-27SWSF4Y	<b>1 114.30</b>	----	----	2.2
SJ3-28SWSF4Y	<b>1 128.91</b>	----	----	2.2
SJ3-29SWSF4Y	<b>1 143.54</b>	----	----	2.2
SJ3-30SWSF4Y	<b>1 158.16</b>	----	----	2.2
SJ3-31SWSF4Y	<b>1 173.17</b>	----	----	2.2
SJ3-32SWSF4Y	<b>1 187.78</b>	----	----	2.2
SJ3-33SWSF4Y	<b>1 475.16</b>	----	----	3
SJ3-34SWSF4Y	<b>1 489.79</b>	----	----	3



SJ3-35SWSF4Y	1 504.40	----	----	3
SJ3-36SWSF4Y	1 519.42	----	----	3
SJ3-37SWSF4Y	1 534.03	----	----	3
SJ3-38SWSF4Y	1 548.66	----	----	3
SJ3-39SWSF4Y	1 563.27	----	----	3
SJ3-40SWSF4Y	1 578.27	----	----	3
SJ3-41SWSF4Y	1 592.89	----	----	3
SJ3-42SWSF4Y	1 607.52	----	----	3
SJ3-43SWSF4Y	1 622.13	----	----	3

### Многоступенчатые погружные насосы из нержавеющей стали SJ 5

4 дюймовый двигатель		6 дюймовый двигатель		Мощность (кВт)
Артикул	Цена розница (USD) с НДС	Артикул	Цена розница (USD) с НДС	
SJ5-1SWSF4Y	500.44	----	----	0.37
SJ5-2SWSF4Y	515.11	----	----	0.37
SJ5-3SWSF4Y	529.78	----	----	0.37
SJ5-4SWSF4Y	544.46	----	----	0.37
SJ5-5SWSF4Y	559.13	----	----	0.55
SJ5-6SWSF4Y	573.79	----	----	0.55
SJ5-7SWSF4Y	629.99	----	----	0.75
SJ5-8SWSF4Y	644.67	----	----	0.75
SJ5-9SWSF4Y	693.57	----	----	1.1
SJ5-10SWSF4Y	708.24	----	----	1.1
SJ5-11SWSF4Y	722.92	----	----	1.1
SJ5-12SWSF4Y	737.97	----	----	1.1
SJ5-13SWSF4Y	801.38	----	----	1.5
SJ5-14SWSF4Y	816.06	----	----	1.5
SJ5-15SWSF4Y	830.73	----	----	1.5
SJ5-16SWSF4Y	845.80	----	----	1.5
SJ5-17SWSF4Y	860.46	----	----	1.5
SJ5-18SWSF4Y	984.74	----	----	2.2
SJ5-19SWSF4Y	1 000.91	----	----	2.2
SJ5-20SWSF4Y	1 015.58	----	----	2.2
SJ5-21SWSF4Y	1 030.65	----	----	2.2
SJ5-22SWSF4Y	1 045.31	----	----	2.2
SJ5-23SWSF4Y	1 060.00	----	----	2.2
SJ5-24SWSF4Y	1 074.66	----	----	2.2
SJ5-25SWSF4Y	1 089.33	----	----	2.2
SJ5-26SWSF4Y	1 371.64	----	----	3
SJ5-27SWSF4Y	1 386.30	----	----	3
SJ5-28SWSF4Y	1 400.97	----	----	3
SJ5-29SWSF4Y	1 415.64	----	----	3
SJ5-30SWSF4Y	1 430.32	----	----	3
SJ5-31SWSF4Y	1 445.37	----	----	3
SJ5-32SWSF4Y	1 460.05	----	----	3
SJ5-33SWSF4Y	1 480.25	----	----	3
SJ5-34SWSF4Y	1 590.85	----	----	4



SJ5-35SWSF4Y	1 605.52	----	----	4
SJ5-36SWSF4Y	1 620.59	----	----	4
SJ5-37SWSF4Y	1 635.25	----	----	4
SJ5-38SWSF4Y	1 649.92	----	----	4
SJ5-39SWSF4Y	1 664.59	----	----	4
SJ5-40SWSF4Y	1 679.66	----	----	4
SJ5-41SWSF4Y	1 694.32	----	----	4
SJ5-42SWSF4Y	1 708.99	----	----	4
SJ5-43SWSF4Y	1 723.66	----	----	4

### Многоступенчатые погружные насосы из нержавеющей стали SJ 8

4 дюймовый двигатель		6 дюймовый двигатель		Мощность (кВт)
Артикул	Цена розница (USD) с НДС	Артикул	Цена розница (USD) с НДС	
SJ8-1SWSF4Y	555.04	----	----	0.37
SJ8-2SWSF4Y	583.92	----	----	0.37
SJ8-3SWSF4Y	612.42	----	----	0.55
SJ8-4SWSF4Y	682.44	----	----	0.75
SJ8-5SWSF4Y	710.94	----	----	0.75
SJ8-6SWSF4Y	773.67	----	----	1.1
SJ8-7SWSF4Y	802.57	----	----	1.1
SJ8-8SWSF4Y	879.05	----	----	1.5
SJ8-9SWSF4Y	907.94	----	----	1.5
SJ8-10SWSF4Y	936.44	----	----	1.5
SJ8-11SWSF4Y	1 074.54	----	----	2.2
SJ8-12SWSF4Y	1 103.43	----	----	2.2
SJ8-13SWSF4Y	1 134.17	----	----	2.2
SJ8-14SWSF4Y	1 163.05	----	----	2.2
SJ8-15SWSF4Y	1 191.55	----	----	2.2
SJ8-16SWSF4Y	1 487.69	----	----	3
SJ8-17SWSF4Y	1 516.18	----	----	3
SJ8-18SWSF4Y	1 544.68	----	----	3
SJ8-19SWSF4Y	1 669.50	----	----	4
SJ8-20SWSF4Y	1 698.00	----	----	4
SJ8-21SWSF4Y	1 726.89	----	----	4
SJ8-22SWSF4Y	1 758.54	----	----	4
SJ8-23SWSF4Y	1 787.43	----	----	4
SJ8-24SWSF4Y	1 815.92	----	----	4
SJ8-25SWSF4Y	1 844.42	----	----	4
SJ8-26SWSF4Y	2 072.03	----	----	5.5
SJ8-27SWSF4Y	2 100.53	----	----	5.5
SJ8-28SWSF4Y	2 129.41	----	----	5.5
SJ8-29SWSF4Y	2 157.91	----	----	5.5
SJ8-30SWSF4Y	2 186.42	----	----	5.5
SJ8-31SWSF4Y	2 220.48	----	----	5.5
SJ8-32SWSF4Y	2 248.98	----	----	5.5
SJ8-33SWSF4Y	2 277.86	----	----	5.5
SJ8-34SWSF4Y	2 306.36	----	----	5.5

SJ8-35SWSF4Y	2 335.24	-----	-----	5.5
SJ8-36SWSF4Y	2 363.74	-----	-----	5.5
SJ8-37SWSF4Y	2 392.23	-----	-----	5.5
SJ8-38SWSF4Y	2 640.42	-----	-----	7.5
SJ8-39SWSF4Y	2 668.92	-----	-----	7.5
SJ8-40SWSF4Y	2 697.80	-----	-----	7.5
SJ8-41SWSF4Y	2 726.30	-----	-----	7.5
SJ8-42SWSF4Y	2 755.34	-----	-----	7.5
SJ8-43SWSF4Y	2 783.84	-----	-----	7.5
SJ8-44SWSF4Y	2 812.34	-----	-----	7.5
SJ8-45SWSF4Y	2 841.07	-----	-----	7.5
SJ8-46SWSF4Y	2 869.57	-----	-----	7.5
SJ8-47SWSF4Y	2 898.45	-----	-----	7.5
SJ8-48SWSF4Y	2 926.95	-----	-----	7.5
SJ8-49SWSF4Y	2 955.45	-----	-----	7.5
SJ8-50SWSF4Y	2 984.34	-----	-----	7.5

### Многоступенчатые погружные насосы из нержавеющей стали SJ 12

4 дюймовый двигатель		6 дюймовый двигатель		Мощность (кВт)
Артикул	Цена розница (USD) с НДС	Артикул	Цена розница (USD) с НДС	
SJ12-1SWSF4Y	584.24	-----	-----	0.37
SJ12-2SWSF4Y	633.20	-----	-----	0.55
SJ12-3SWSF4Y	757.09	-----	-----	1.1
SJ12-4SWSF4Y	806.04	-----	-----	1.1
SJ12-5SWSF4Y	902.98	-----	-----	1.5
SJ12-6SWSF4Y	1 061.10	-----	-----	2.2
SJ12-7SWSF4Y	1 110.05	-----	-----	2.2
SJ12-8SWSF4Y	1 426.25	-----	-----	3
SJ12-9SWSF4Y	1 474.76	-----	-----	3
SJ12-10SWSF4Y	1 523.72	-----	-----	3
SJ12-11SWSF4Y	1 668.61	-----	-----	4
SJ12-12SWSF4Y	1 717.12	-----	-----	4
SJ12-13SWSF4Y	1 768.61	-----	-----	4
SJ12-14SWSF4Y	2 016.31	-----	-----	5.5
SJ12-15SWSF4Y	2 064.82	-----	-----	5.5
SJ12-16SWSF4Y	2 113.76	-----	-----	5.5
SJ12-17SWSF4Y	2 162.72	-----	-----	5.5
SJ12-18SWSF4Y	2 211.48	-----	-----	5.5
SJ12-19SWSF4Y	2 479.48	-----	-----	7.5
SJ12-20SWSF4Y	2 528.43	-----	-----	7.5
SJ12-21SWSF4Y	2 576.95	-----	-----	7.5
SJ12-22SWSF4Y	2 629.47	-----	-----	7.5
SJ12-23SWSF4Y	2 678.41	-----	-----	7.5
SJ12-24SWSF4Y	2 726.93	-----	-----	7.5
SJ12-25SWSF4Y	2 775.88	-----	-----	7.5

## Многоступенчатые погружные насосы из нержавеющей стали SJ 17

4 дюймовый двигатель		6 дюймовый двигатель		Мощность (кВт)
Артикул	Цена розница (USD) с НДС	Артикул	Цена розница (USD) с НДС	
SJ17-1SWSF4Y	737.16	----	-----	0.55
SJ17-2SWSF4Y	888.12	----	-----	1.1
SJ17-3SWSF4Y	1 121.87	----	-----	2.2
SJ17-4SWSF4Y	1 198.02	----	-----	2.2
SJ17-5SWSF4Y	1 540.86	----	-----	3
SJ17-6SWSF4Y	1 717.76	SJ17-6SWSP6Y	2 663.57	4
SJ17-7SWSF4Y	1 793.90	SJ17-7SWSP6Y	2 744.48	4
SJ17-8SWSF4Y	2 068.23	SJ17-8SWSP6Y	2 874.56	5.5
SJ17-9SWSF4Y	2 144.39	SJ17-9SWSP6Y	2 951.44	5.5
SJ17-10SWSF4Y	2 219.99	SJ17-10SWSP6Y	3 027.76	5.5
SJ17-11SWSF4Y	2 515.42	SJ17-11SWSP6Y	3 275.94	7.5
SJ17-12SWSF4Y	2 591.56	SJ17-12SWSP6Y	3 352.80	7.5
SJ17-13SWSF4Y	2 667.16	SJ17-13SWSP6Y	3 429.12	7.5
----	-----	SJ17-14SWSP6Y	3 715.41	9.2
----	-----	SJ17-15SWSP6Y	3 791.73	9.2
----	-----	SJ17-16SWSP6Y	3 868.59	9.2
----	-----	SJ17-17SWSP6Y	3 945.47	9.2
----	-----	SJ17-18SWSP6Y	4 261.61	11
----	-----	SJ17-19SWSP6Y	4 338.47	11
----	-----	SJ17-20SWSP6Y	4 415.34	11
----	-----	SJ17-21SWSP6Y	4 666.79	13
----	-----	SJ17-22SWSP6Y	4 743.67	13
----	-----	SJ17-23SWSP6Y	4 819.99	13
----	-----	SJ17-24SWSP6Y	4 896.86	13
----	-----	SJ17-25SWSP6Y	5 247.83	15
----	-----	SJ17-26SWSP6Y	5 324.16	15

## Многоступенчатые погружные насосы из нержавеющей стали SJ 30

4 дюймовый двигатель		6 дюймовый двигатель		Мощность (кВт)
Артикул	Цена розница (USD) с НДС	Артикул	Цена розница (USD) с НДС	
SJ30-1SWSF4Y	857.40	----	-----	1.1
SJ30-2SWSF4Y	1 110.80	----	-----	2.2
SJ30-3SWSF4Y	1 484.21	----	-----	3
SJ30-4SWSF4Y	1 686.32	----	-----	4
SJ30-5SWSF4Y	1 991.22	SJ30-5SWSP6Y	2 797.46	5.5
SJ30-6SWSF4Y	2 102.21	SJ30-6SWSP6Y	2 907.54	5.5
SJ30-7SWSF4Y	2 427.66	SJ30-7SWSP6Y	3 188.94	7.5
SJ30-8SWSF4Y	2 533.84	SJ30-8SWSP6Y	3 299.04	7.5
----	-----	SJ30-9SWSP6Y	3 614.72	9.2
----	-----	SJ30-10SWSP6Y	3 724.82	9.2
----	-----	SJ30-11SWSP6Y	3 834.92	9.2

----	----	SJ30-12SWSP6Y	<b>4 184.82</b>	11
----	----	SJ30-13SWSP6Y	<b>4 294.91</b>	11
----	----	SJ30-14SWSP6Y	<b>4 580.14</b>	13
----	----	SJ30-15SWSP6Y	<b>4 690.24</b>	13
----	----	SJ30-16SWSP6Y	<b>5 074.44</b>	15
----	----	SJ30-17SWSP6Y	<b>5 184.52</b>	15
----	----	SJ30-18SWSP6Y	<b>5 568.72</b>	18.5
----	----	SJ30-19SWSP6Y	<b>5 678.82</b>	18.5
----	----	SJ30-20SWSP6Y	<b>5 788.90</b>	18.5
----	----	SJ30-21SWSP6Y	<b>5 902.84</b>	18.5
----	----	SJ30-22SWSP6Y	<b>6 424.04</b>	22
----	----	SJ30-23SWSP6Y	<b>6 533.60</b>	22
----	----	SJ30-24SWSP6Y	<b>6 643.69</b>	22
----	----	SJ30-25SWSP6Y	<b>6 753.79</b>	22

### Многоступенчатые погружные насосы из нержавеющей стали SJ 42

4 дюймовый двигатель		6 дюймовый двигатель		Мощность (кВт)
Артикул	Цена розница (USD) с НДС	Артикул	Цена розница (USD) с НДС	
SJ42-1SWSF4Y	<b>1 096.53</b>	----	----	2.2
SJ42-2SWSF4Y	<b>1 497.14</b>	----	----	3
SJ42-3SWSF4Y	<b>1 935.18</b>	SJ42-3SWSP6Y	<b>2 736.36</b>	5.5
SJ42-4SWSF4Y	<b>2 297.85</b>	SJ42-4SWSP6Y	<b>3 052.81</b>	7.5
SJ42-5SWSF4Y	<b>2 441.24</b>	SJ42-5SWSP6Y	<b>3 197.93</b>	7.5
----	----	SJ42-6SWSP6Y	<b>3 557.20</b>	9.2
----	----	SJ42-7SWSP6Y	<b>3 942.14</b>	11
----	----	SJ42-8SWSP6Y	<b>4 258.57</b>	13
----	----	SJ42-9SWSP6Y	<b>4 678.47</b>	15
----	----	SJ42-10SWSP6Y	<b>4 823.60</b>	15
----	----	SJ42-11SWSP6Y	<b>5 242.81</b>	18.5
----	----	SJ42-12SWSP6Y	<b>5 387.94</b>	18.5
----	----	SJ42-13SWSP6Y	<b>5 944.19</b>	22
----	----	SJ42-14SWSP6Y	<b>6 091.60</b>	22
----	----	SJ42-15SWSP6Y	<b>6 236.73</b>	22
----	----	SJ42-16SWSP6Y	<b>6 911.90</b>	25
----	----	SJ42-17SWSP6Y	<b>7 057.69</b>	25
----	----	SJ42-18SWSP6Y	<b>7 495.06</b>	30
----	----	SJ42-19SWSP6Y	<b>7 640.19</b>	30
----	----	SJ42-20SWSP6Y	<b>7 785.31</b>	30
----	----	SJ42-21SWSP6Y	<b>8 815.61</b>	37
----	----	SJ42-22SWSP6Y	<b>8 978.38</b>	37

### Многоступенчатые погружные насосы из нержавеющей стали SJ 60

4 дюймовый двигатель		6 дюймовый двигатель		Мощность (кВт)
Артикул	Цена розница (USD) с НДС	Артикул	Цена розница (USD) с НДС	
SJ60-1SWSF4Y	<b>1 125.65</b>	----	----	2.2

SJ60-2-2SWSF4Y	<b>1 537.80</b>	-----	-----	3
SJ60-2SWSF4Y	<b>1 633.74</b>	-----	-----	4
SJ60-3-2SWSF4Y	<b>1 988.17</b>	SJ60-3-2SWSP6Y	<b>2 789.55</b>	5.5
SJ60-3SWSF4Y	<b>1 988.17</b>	SJ60-3SWSP6Y	<b>2 789.55</b>	5.5
SJ60-4SWSF4Y	<b>2 363.16</b>	SJ60-4SWSP6Y	<b>3 118.32</b>	7.5
-----	-----	SJ60-5SWSP6Y	<b>3 481.35</b>	9.2
-----	-----	SJ60-6SWSP6Y	<b>3 887.85</b>	11
-----	-----	SJ60-7SWSP6Y	<b>4 216.59</b>	13
-----	-----	SJ60-8-2SWSP6Y	<b>4 374.05</b>	13
-----	-----	SJ60-8SWSP6Y	<b>4 648.14</b>	15
-----	-----	SJ60-9-2SWSP6Y	<b>4 806.32</b>	15
-----	-----	SJ60-9SWSP6Y	<b>5 080.41</b>	18.5
-----	-----	SJ60-10SWSP6Y	<b>5 237.87</b>	18.5
-----	-----	SJ60-11SWSP6Y	<b>5 806.45</b>	22
-----	-----	SJ60-12SWSP6Y	<b>5 963.90</b>	22
-----	-----	SJ60-13SWSP6Y	<b>6 123.81</b>	22
-----	-----	SJ60-14SWSP6Y	<b>6 811.31</b>	25
-----	-----	SJ60-15SWSP6Y	<b>6 968.77</b>	25
-----	-----	SJ60-16SWSP6Y	<b>7 418.45</b>	30
-----	-----	SJ60-17SWSP6Y	<b>7 576.62</b>	30
-----	-----	SJ60-18SWSP6Y	<b>7 734.08</b>	30
-----	-----	SJ60-19SWSP6Y	<b>8 767.35</b>	37
-----	-----	SJ60-20SWSP6Y	<b>8 943.77</b>	37
-----	-----	SJ60-21SWSP6Y	<b>9 120.22</b>	37

### Многоступенчатые погружные насосы из нержавеющей стали SJ 75

6 дюймовый двигатель		8 дюймовый двигатель		Мощность (кВт)
Артикул	Цена розница (USD) с НДС	Артикул	Цена розница (USD) с НДС	
SJ75-1SWSP6Y	<b>3 209.33</b>	-----	-----	4
SJ75-2SWSP6Y	<b>3 255.11</b>	SJ75-2SWSP8S	<b>4 582.50</b>	7.5
SJ75-3SWSP6Y	<b>4 238.52</b>	SJ75-3SWSP8S	<b>5 062.74</b>	11
SJ75-4SWSP6Y	<b>4 590.59</b>	SJ75-4SWSP8S	<b>5 359.52</b>	15
SJ75-5SWSP6Y	<b>4 825.31</b>	SJ75-5SWSP8S	<b>5 668.44</b>	18.5
SJ75-6SWSP6Y	<b>5 339.28</b>	SJ75-6SWSP8S	<b>5 953.07</b>	22
SJ75-7SWSP6Y	<b>6 789.44</b>	SJ75-7SWSP8S	<b>7 468.40</b>	30
SJ75-8SWSP6Y	<b>6 789.44</b>	SJ75-8SWSP8S	<b>7 468.40</b>	30
SJ75-9SWSP6Y	<b>7 917.19</b>	SJ75-9SWSP8S	<b>8 708.91</b>	37
SJ75-10SWSP6Y	<b>7 917.19</b>	SJ75-10SWSP8S	<b>8 708.91</b>	37
-----	-----	SJ75-11SWSP8S	<b>8 742.77</b>	45
-----	-----	SJ75-12SWSP8S	<b>8 742.77</b>	45
-----	-----	SJ75-13SWSP8S	по запросу	55
-----	-----	SJ75-14SWSP8S		55
-----	-----	SJ75-15SWSP8S		55
-----	-----	SJ75-16SWSP8S		63
-----	-----	SJ75-17SWSP8S		63
-----	-----	SJ75-18SWSP8S		75
-----	-----	SJ75-19SWSP8S		75

-----	-----	SJ75-20SWSP8S	75
-------	-------	---------------	----

## Многоступенчатые погружные насосы из нержавеющей стали SJ 95

6 дюймовый двигатель		8 дюймовый двигатель		Мощность (кВт)
Артикул	Цена розница (USD) с НДС	Артикул	Цена розница (USD) с НДС	
SJ95-2SWSP6Y	3 971.41	SJ95-2SWSP8S	4 825.31	9.2
SJ95-3SWSP6Y	4 590.59	SJ95-3SWSP8S	5 359.52	13
SJ95-4SWSP6Y	4 825.31	SJ95-4SWSP8S	5 668.44	18.5
SJ95-5SWSP6Y	5 339.28	SJ95-5SWSP8S	5 953.07	22
SJ95-6SWSP6Y	6 109.56	SJ95-6SWSP8S	6 487.27	25
SJ95-7SWSP6Y	6 789.44	SJ95-7SWSP8S	7 468.40	30
SJ95-8SWSP6Y	7 917.19	SJ95-8SWSP8S	8 708.91	37
SJ95-9SWSP6Y	7 917.19	SJ95-9SWSP8S	8 708.91	37
-----	-----	SJ95-10SWSP8S	8 742.77	45
-----	-----	SJ95-11SWSP8S	8 742.77	45
-----	-----	SJ95-12SWSP8S	по запросу	55
-----	-----	SJ95-13SWSP8S		55
-----	-----	SJ95-14SWSP8S		55
-----	-----	SJ95-15SWSP8S		63
-----	-----	SJ95-16SWSP8S		63
-----	-----	SJ95-17SWSP8S		75
-----	-----	SJ95-18SWSP8S		75

## Многоступенчатые погружные насосы из нержавеющей стали SJ 120

6 дюймовый двигатель		8 дюймовый двигатель		Мощность (кВт)
Артикул	Цена розница (USD) с НДС	Артикул	Цена розница (USD) с НДС	
SJ 120-1SWSP6Y	5 240.47	SJ 120-1SWSP8S	6 152.15	11
SJ 120-2-2SWSP6Y	6 246.78	SJ 120-2-2SWSP8S	7 235.85	15
SJ 120-2-1SWSP6Y	6 734.03	SJ 120-2-1SWSP8S	7 470.35	18.5
SJ 120-2SWSP6Y	6 968.30	SJ 120-2SWSP8S	7 778.13	22
SJ 120-3-2SWSP6Y	7 930.60	SJ 120-3-2SWSP8S	8 767.49	25
SJ 120-3-1SWSP6Y	9 027.49	SJ 120-3-1SWSP8S	9 067.29	30
SJ 120-3SWSP6Y	9 033.32	SJ 120-3SWSP8S	9 067.29	30
SJ 120-4-2SWSP6Y	10 151.56	SJ 120-4-2SWSP8S	10 554.76	37
SJ 120-4-1SWSP6Y	10 151.56	SJ 120-4-1SWSP8S	10 554.76	37
SJ 120-4SWSP6Y	10 156.12	SJ 120-4SWSP8S	10 554.76	37
-----	-----	SJ 120-5-2SWSP8S	11 813.15	45
-----	-----	SJ 120-5-1SWSP8S	11 813.15	45
-----	-----	SJ 120-5SWSP8S	по запросу	55
-----	-----	SJ 120-6-2SWSP8S		55
-----	-----	SJ 120-6-1SWSP8S		55
-----	-----	SJ 120-6SWSP8S		63
-----	-----	SJ 120-7-2SWSP8S		63
-----	-----	SJ 120-7-1SWSP8S		63
-----	-----	SJ 120-7SWSP8S		75
-----	-----	SJ 120-8-2SWSP8S		75

----	----	SJ 120-8-1SWSP8S	по запросу	75
----	----	SJ 120-8SWSP8S		75
----	----	SJ 120-9-2SWSP8S		90
----	----	SJ 120-9-1SWSP8S		90
----	----	SJ 120-9SWSP8S		90
----	----	SJ 120-10-2SWSP8S		90
----	----	SJ 120-10-1SWSP8S		90
----	----	SJ 120-10SWSP8S		110
----	----	SJ 120-11-2SWSP8S		110
----	----	SJ 120-11-1SWSP8S		110
----	----	SJ 120-11SWSP8S		110

### Многоступенчатые погружные насосы из нержавеющей стали SJ 150

6 дюймовый двигатель		8 дюймовый двигатель		Мощность (кВт)
Артикул	Цена розница (USD) с НДС	Артикул	Цена розница (USD) с НДС	
SJ 150-1-1SWSP6Y	5 113.01	SJ 150-1-1SWSP8S	6 073.93	9.2
SJ 150-1SWSP6Y	5 443.67	SJ 150-1SWSP8S	6 500.86	13
SJ 150-2-2SWSP6Y	6 734.07	SJ 150-2-2SWSP8S	7 463.61	18.5
SJ 150-2-1SWSP6Y	6 965.06	SJ 150-2-1SWSP8S	7 771.10	22
SJ 150-2SWSP6Y	7 210.35	SJ 150-2SWSP8S	8 032.72	25
SJ 150-3-2SWSP6Y	9 027.49	SJ 150-3-2SWSP8S	9 059.01	30
SJ 150-3-1SWSP6Y	9 430.67	SJ 150-3-1SWSP8S	9 817.86	37
SJ 150-3SWSP6Y	9 430.67	SJ 150-3SWSP8S	9 817.86	37
----	----	SJ 150-4-2SWSP8S	11 075.06	45
----	----	SJ 150-4-1SWSP8S	11 075.06	45
----	----	SJ 150-4SWSP8S	по запросу	55
----	----	SJ 150-5-2SWSP8S		55
----	----	SJ 150-5-1SWSP8S		55
----	----	SJ 150-5SWSP8S		63
----	----	SJ 150-6-2SWSP8S		63
----	----	SJ 150-6-1SWSP8S		75
----	----	SJ 150-6SWSP8S		75
----	----	SJ 150-7-2SWSP8S		75
----	----	SJ 150-7-1SWSP8S		90
----	----	SJ 150-7SWSP8S		90
----	----	SJ 150-8-2SWSP8S		90
----	----	SJ 150-8-1SWSP8S		110
----	----	SJ 150-8SWSP8S		110
----	----	SJ 150-9-2SWSP8S		110
----	----	SJ 150-9-1SWSP8S		110
----	----	SJ 150-9SWSP8S	110	

### Многоступенчатые погружные насосы из нержавеющей стали SJ 200

10 дюймовый двигатель		Мощность (кВт)
Артикул	Цена розница (USD) с НДС	

SJ200-1SWSP10S	<b>12 382.23</b>	30
SJ200-2-2BSWSP10S	<b>14 033.72</b>	37
SJ200-2-2ASWSP10S	<b>14 457.57</b>	45
SJ200-2-ASWSP10S	<b>по запросу</b>	55
SJ200-2SWSP10S		55
SJ200-3-2BSWSP10S		75
SJ200-3-A-BSWSP10S		75
SJ200-3-2ASWSP10S		75
SJ200-3-BSWSP10S		75
SJ200-3-ASWSP10S		75
SJ200-3SWSP10S		90
SJ200-4-2BSWSP10S		90
SJ200-4-2ASWSP10S		110
SJ200-4-ASWSP10S		110
SJ200-4SWSP10S		110





## SM многоступенчатые погружные насосы из нержавеющей стали (пласт.раб.колесо)

1. Все агрегаты электронасосные поставляются с кабелем длиной
2. Однофазные электродвигатели агрегатов электронасосных комплектуются
3. Возможна комплектация охлаждающим кожухом из ПВХ. Стоимость предоставляется по запросу.

**ТОЛЬКО ДЛЯ ВЕРТИКАЛЬНОЙ УСТАНОВКИ!!! Горизонтальный монтаж категорически запрещен!**

**обновление  
15.02.2023**

Модель/Артикул	Цена розница (USD) с НДС	Мощность, кВт	Модель/Артикул	Цена розница (USD) с НДС
1ф, 220В			3ф., 380В	
SM(A)1.8-11 D	201.70	0.25		
SM(A)1.8-15 D	224.52	0.37		
SM(A)1.8-21 D	259.33	0.55		
SM(A)1.8-27 D	306.16	0.75		
SM(A)1.8-39 D	384.20	1.1		
SM(A)2.5-8 D	195.70	0.25		
SM(A)2.5-11 D	212.51	0.37		
SM(A)2.5-16 D	249.73	0.55		
SM(A)2.5-21 D	289.35	0.75		
SM(A)2.5-30 D	357.79	1.1		
SM(B)2-9 D	253.33	0.37	SM(B)2-9 S	248.53
SM(B)2-13 D	285.75	0.55	SM(B)2-13 S	280.95
SM(B)2-16 D	316.96	0.75	SM(B)2-16 S	310.96

SM(B)2-18 D	<b>336.17</b>	0.95	SM(B)2-18 S	<b>330.17</b>
SM(B)2-22 D	<b>385.40</b>	1.1	SM(B)2-22 S	<b>377.00</b>
SM(B)2-28 D	<b>440.63</b>	1.5	SM(B)2-28 S	<b>432.22</b>
SM(B)3-8 D	<b>253.33</b>	0.37	SM(B)3-8 S	<b>248.53</b>
SM(B)3-11 D	<b>291.75</b>	0.55	SM(B)3-11 S	<b>285.75</b>
SM(B)3-13 D	<b>313.36</b>	0.75	SM(B)3-13 S	<b>307.36</b>
SM(B)3-15 D	<b>332.57</b>	0.95	SM(B)3-15 S	<b>325.37</b>
SM(B)3-19 D	<b>377.00</b>	1.1	SM(B)3-19 S	<b>368.59</b>
SM(B)3-23 D	<b>422.62</b>	1.5	SM(B)3-23 S	<b>399.81</b>
SM(B1)2-9 D	<b>208.91</b>	0.37	SM(B1)2-9 S	<b>225.72</b>
SM(B1)2-13 D	<b>237.72</b>	0.55	SM(B1)2-13 S	<b>255.73</b>
SM(B1)2-16 D	<b>270.14</b>	0.75	SM(B1)2-16 S	<b>290.55</b>
SM(B1)2-18 D	<b>286.95</b>	0.95	SM(B1)2-18 S	<b>310.96</b>
SM(B1)2-22 D	<b>327.77</b>	1.1	SM(B1)2-22 S	<b>354.18</b>
SM(B1)2-28 D	<b>383.00</b>	1.5	SM(B1)2-28 S	<b>404.61</b>
SM(B1)3-8 D	<b>210.11</b>	0.37	SM(B1)3-8 S	<b>226.92</b>
SM(B1)3-11 D	<b>241.33</b>	0.55	SM(B1)3-11 S	<b>259.33</b>
SM(B1)3-13 D	<b>265.34</b>	0.75	SM(B1)3-13 S	<b>285.75</b>
SM(B1)3-15 D	<b>276.14</b>	0.95	SM(B1)3-15 S	<b>298.96</b>
SM(B1)3-19 D	<b>320.57</b>	1.1	SM(B1)3-19 S	<b>345.78</b>
SM(B1)3-23 D	<b>374.59</b>	1.5	SM(B1)3-23 S	<b>396.21</b>
SM(C)2-8 D	<b>247.33</b>	0.37	SM(C)2-8 S	<b>224.52</b>
SM(C)2-11 D	<b>277.34</b>	0.55	SM(C)2-11 S	<b>254.53</b>
SM(C)2-14 D	<b>320.57</b>	0.75	SM(C)2-14 S	<b>297.75</b>
SM(C)2-19 D	<b>370.99</b>	1.1	SM(C)2-19 S	<b>345.78</b>
SM(C)2-25 D	<b>438.23</b>	1.5	SM(C)2-25 S	<b>411.81</b>
SM(C)2-38 D	<b>555.89</b>	2.2	SM(C)2-38 S	<b>533.08</b>
		3	SM(C)2-52 S	<b>818.82</b>
		4	SM(C)2-65 S	<b>934.08</b>
SM(C)3-6 D	<b>229.32</b>	0.37	SM(C)3-6 S	<b>242.53</b>
SM(C)3-9 D	<b>270.14</b>	0.55	SM(C)3-9 S	<b>265.34</b>
SM(C)3-11 D	<b>303.76</b>	0.75	SM(C)3-11 S	<b>297.75</b>
SM(C)3-15 D	<b>357.79</b>	1.1	SM(C)3-15 S	<b>351.78</b>
SM(C)3-20 D	<b>410.61</b>	1.5	SM(C)3-20 S	<b>398.61</b>
SM(C)3-27 D	<b>479.05</b>	2.2	SM(C)3-27 S	<b>505.46</b>
		3	SM(C)3-40 S	<b>609.92</b>
		4	SM(C)3-50 S	<b>883.66</b>
		5.5	SM(C)3-62 S	<b>1 168.21</b>
SM(C)4-7 D	<b>246.13</b>	0.55	SM(C)4-7 S	<b>242.53</b>
SM(C)4-9 D	<b>296.55</b>	0.75	SM(C)4-9 S	<b>272.54</b>
SM(C)4-12 D	<b>350.58</b>	1.1	SM(C)4-12 S	<b>321.77</b>

SM(C)4-16 D	<b>397.41</b>	1.5	SM(C)4-16 S	<b>368.59</b>
SM(C)4-22 D	<b>474.25</b>	2.2	SM(C)4-22 S	<b>443.03</b>
		3	SM(C)4-32 S	<b>581.10</b>
		4	SM(C)4-40 S	<b>762.40</b>
		5.5	SM(C)4-50 S	<b>1 180.21</b>
		7.5	SM(C)4-62 S	<b>1 314.68</b>
SM(C)6-6 D	<b>253.33</b>	0.55	SM(C)6-6 S	<b>249.73</b>
SM(C)6-8 D	<b>303.76</b>	0.75	SM(C)6-8 S	<b>278.54</b>
SM(C)6-11 D	<b>350.58</b>	1.1	SM(C)6-11 S	<b>321.77</b>
SM(C)6-14 D	<b>405.81</b>	1.5	SM(C)6-14 S	<b>377.00</b>
SM(C)6-20 D	<b>488.65</b>	2.2	SM(C)6-20 S	<b>457.44</b>
		3	SM(C)6-28 S	<b>603.91</b>
		4	SM(C)6-36 S	<b>673.55</b>
		5.5	SM(C)6-46 S	<b>1 040.94</b>
		7.5	SM(C)6-52 S	<b>1 221.03</b>
SM(C)8-5 D	<b>249.73</b>	0.55	SM(C)8-5 S	<b>246.13</b>
SM(C)8-6 D	<b>295.35</b>	0.75	SM(C)8-6 S	<b>271.34</b>
SM(C)8-8 D	<b>339.78</b>	1.1	SM(C)8-8 S	<b>310.96</b>
SM(C)8-11 D	<b>391.40</b>	1.5	SM(C)8-11 S	<b>362.59</b>
SM(C)8-15 D	<b>461.04</b>	2.2	SM(C)8-15 S	<b>428.62</b>
		3	SM(C)8-20 S	<b>555.89</b>
		4	SM(C)8-28 S	<b>661.54</b>
		5.5	SM(C)8-36 S	<b>899.27</b>
		7.5	SM(C)8-44 S	<b>1 210.23</b>
SM(C)10-5 D	<b>272.54</b>	0.75	SM(C)10-5 S	<b>268.94</b>
SM(C)10-6 D	<b>334.97</b>	1.1	SM(C)10-6 S	<b>303.76</b>
SM(C)10-9 D	<b>379.40</b>	1.5	SM(C)10-9 S	<b>349.38</b>
SM(C)10-13 D	<b>452.63</b>	2.2	SM(C)10-13 S	<b>417.82</b>
		3	SM(C)10-18 S	<b>541.48</b>
		4	SM(C)10-23 S	<b>624.32</b>
		5.5	SM(C)10-28 S	<b>862.05</b>
		7.5	SM(C)10-36 S	<b>991.71</b>
SM(C)16-5 D	<b>458.64</b>	1.1	SM(C)16-5 S	<b>450.23</b>
SM(C)16-7 D	<b>499.46</b>	1.5	SM(C)16-7 S	<b>489.85</b>
SM(C)16-10 D	<b>540.28</b>	2.2	SM(C)16-10 S	<b>529.47</b>
		3	SM(C)16-13 S	<b>650.74</b>
		4	SM(C)16-17 S	<b>759.99</b>
		5.5	SM(C)16-22 S	<b>1 026.53</b>
		7.5	SM(C)16-28 S	<b>1 215.03</b>
		2.2	SM(G)25-2 S	<b>632.73</b>
		3	SM(G)25-3 S	<b>715.57</b>

<b>4</b>	<b>SM(G)25-4 S</b>	<b>785.21</b>
<b>5.5</b>	<b>SM(G)25-5 S</b>	<b>960.50</b>
<b>7.5</b>	<b>SM(G)25-7 S</b>	<b>1 108.17</b>
<b>9.2</b>	<b>SM(G)25-9 S</b>	<b>1 363.91</b>
<b>11</b>	<b>SM(G)25-11 S</b>	<b>1 642.45</b>
<b>13</b>	<b>SM(G)25-13 S</b>	<b>1 794.93</b>
<b>15</b>	<b>SM(G)25-15 S</b>	<b>1 929.40</b>
	<b>SM(F1)12-24 S</b>	<b>1 425.50</b>
	<b>SM(F1)12-29 S</b>	<b>1 701.02</b>

## Погружные электронасосы WQ для отвода канализационных сточных вод

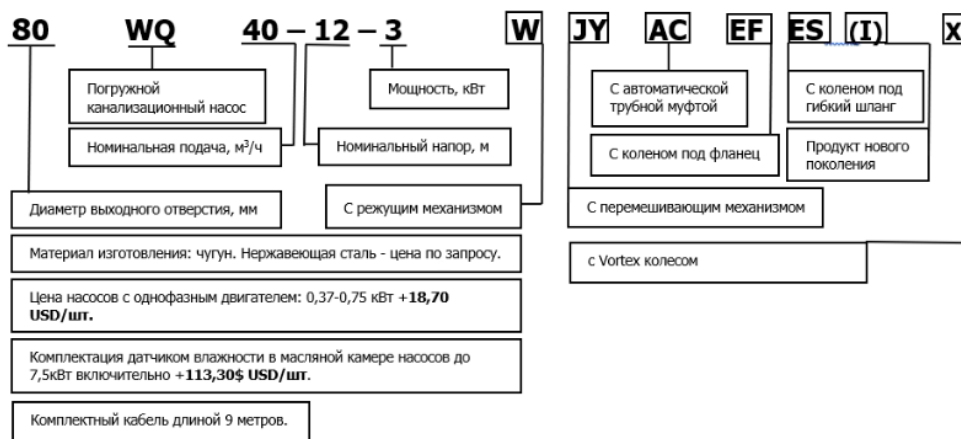

Комплектация насосов серии WQ ATM		
Модель ATM	Применяется для	Примечание
TOS-40~150 TO-150~500	Насосы WQ мощностью более 0.55 кВт (за исключением 4-х полюсных моделей DN100 мощностью 18.5-22 кВт и насосов серии WQ-H).	Стандартная автоматическая трубная муфта
TOS-80F TOS-100F	4-х полюсные насосы с напорным патрубком DN100 и мощностью 18.5-22 кВт (например, 100WQ100-39-22AC(I); насосы серии WQ-H).	Усиленная автоматическая трубная муфта

**обновление**  
**15.02.2023**

Модель/арт. WQ с АТМ	Скорость, об/мин	DN	Цена розница WQ, USD с НДС		
			с АТМ	под гибкий шланг/ под АТМ	колено с фланцем
<b>2-х полюсные</b>					
40WQ12-10-0.75AC(I)	2850	40	<b>866.48</b>	533.86	574.39
40WQ8-15-1.1AC(I)	2850	40	<b>939.15</b>	606.54	645.67
40WQ15-8-1.1AC(I)	2850	40	<b>939.15</b>	606.54	645.67
40WQ15-13-1.1AC(I)	2850	40	<b>939.15</b>	606.54	645.67
40WQ12-18-1.5AC(I)	2880	40	<b>1 048.16</b>	715.55	756.07
50WQ10-7-0.55AC(I)	2850	50	<b>933.56</b>	546.44	593.96
50WQ12-10-0.75AC(I)	2850	50	<b>933.56</b>	546.44	593.96
50WQ8-15-1.1AC(I)	2850	50	<b>993.66</b>	606.54	654.05
50WQ10-13-1.1AC(I)	2850	50	<b>993.66</b>	606.54	654.05
50WQ15-8-1.1AC(I)	2850	50	<b>993.66</b>	606.54	654.05
50WQ15-13-1.1AC(I)	2850	50	<b>993.66</b>	606.54	654.05
50WQ10-15-1.5AC(I)	2880	50	<b>1 102.67</b>	715.55	764.46
50WQ10-18-1.5AC(I)	2880	50	<b>1 102.67</b>	715.55	764.46
50WQ12-12-1.5AC(I)	2880	50	<b>1 102.67</b>	715.55	764.46
50WQ15-10-1.5AC(I)	2880	50	<b>1 102.67</b>	715.55	764.46
50WQ15-15-1.5AC(I)	2880	50	<b>1 102.67</b>	715.55	764.46
50WQ9-22-2.2AC(I)	2880	50	<b>1 220.06</b>	832.94	883.25
50WQ15-18-2.2AC(I)	2880	50	<b>1 220.06</b>	832.94	883.25
50WQ15-20-2.2AC(I)	2880	50	<b>1 220.06</b>	832.94	883.25
50WQ20-15-2.2AC(I)	2880	50	<b>1 220.06</b>	832.94	883.25
50WQ25-10-2.2AC(I)	2880	50	<b>1 220.06</b>	832.94	883.25
50WQ15-25-3AC(I)	2840	50	<b>1 302.52</b>	915.40	965.71
50WQ15-27-3AC(I)	2840	50	<b>1 302.52</b>	915.40	965.71
50WQ25-20-3AC(I)	2840	50	<b>1 302.52</b>	915.40	965.71
50WQ15-32-4AC(I)	2840	50	<b>1 660.29</b>	1 273.17	1 320.68
50WQ15-40-5.5AC(I)	2940	50	<b>1 864.33</b>	1 477.21	1 526.12
50WQ20-30-5.5AC(I)	2940	50	<b>1 864.33</b>	1 477.21	1 526.12
50WQ25-25-5.5AC(I)	2940	50	<b>1 864.33</b>	1 477.21	1 526.12
50WQ20-40-7.5AC(I)	2940	50	<b>2 427.54</b>	2 040.42	2 089.34
50WQ25-35-7.5AC(I)	2940	50	<b>2 427.54</b>	2 040.42	2 089.34
65WQ15-10-1.1AC(I)	2850	65	<b>1 133.41</b>	606.54	669.43
65WQ25-10-1.5AC(I)	2850	65	<b>1 256.40</b>	729.52	793.81
65WQ25-14-2.2AC(I)	2880	65	<b>1 359.82</b>	832.94	897.23
65WQ35-7-2.2AC(I)	2880	65	<b>1 359.82</b>	832.94	897.23
65WQ25-15-3AC(I)	2840	65	<b>1 442.27</b>	915.40	979.68
65WQ25-18-3AC(I)	2840	65	<b>1 442.27</b>	915.40	979.68
65WQ37-13-3AC(I)	2840	65	<b>1 442.27</b>	915.40	979.68

65WQ40-10-3AC(I)	2840	65	<b>1 442.27</b>	915.40	979.68
65WQ20-25-4AC(I)	2840	65	<b>1 800.04</b>	1 273.17	1 337.46
65WQ20-27-4AC(I)	2840	65	<b>1 800.04</b>	1 273.17	1 337.46
65WQ25-31-5.5AC(I)	2940	65	<b>2 004.09</b>	1 477.21	1 541.50
65WQ30-25-5.5AC(I)	2940	65	<b>2 004.09</b>	1 477.21	1 541.50
65WQ20-60-11AC(I) Ductile iron	2930	50	<b>4 017.96</b>	3 491.08	3 555.37
65WQ40-50-11AC(I) Ductile iron	2930	65	<b>4 017.96</b>	3 491.08	3 555.37
65WQ30-60-15AC(I) Ductile iron	2930	65	<b>4 505.70</b>	3 978.82	4 082.24
65WQ50-55-15AC(I) Ductile iron	2930	65	<b>4 505.70</b>	3 978.82	4 082.24
80WQ40-8-2.2AC(I)	2880	80	<b>1 565.26</b>	852.51	934.96
80WQ40-10-2.2AC(I)	2880	80	<b>1 565.26</b>	852.51	934.96
80WQ45-9-2.2AC(I)	2880	80	<b>1 565.26</b>	852.51	934.96
80WQ35-13-3AC(I)	2840	80	<b>1 639.33</b>	926.58	1 009.03
80WQ40-15-4AC(I)	2840	80	<b>2 012.47</b>	1 299.72	1 382.18
80WQ40-22-5.5AC(I)	2940	80	<b>2 245.86</b>	1 533.11	1 615.57
80WQ40-30-7.5AC(I)	2940	80	<b>2 883.15</b>	2 170.40	2 252.85
80WQ50-25-7.5AC(I)	2940	80	<b>2 883.15</b>	2 170.40	2 252.85
80WQ48-38-11AC(I)	2930	80	<b>3 922.92</b>	3 210.17	3 292.63
100WQ50-7-2.2AC(I)	2880	100	<b>1 805.63</b>	852.51	971.30
100WQ60-9-3AC(I)	2840	100	<b>1 906.26</b>	953.13	1 071.92
100WQ50-12-4AC(I)	2840	100	<b>2 252.85</b>	1 299.72	1 419.91
100WQ65-15-5.5AC(I)	2940	100	<b>2 529.57</b>	1 576.44	1 695.23
100WQ65-18-5.5AC(I)	2940	100	<b>2 529.57</b>	1 576.44	1 695.23
100WQ70-14-5.5AC(I)	2940	100	<b>2 529.57</b>	1 576.44	1 695.23
100WQ45-22-7.5AC(I)	2940	100	<b>3 143.09</b>	2 189.96	2 308.75
100WQ65-20-7.5AC(I)	2940	100	<b>3 143.09</b>	2 189.96	2 308.75
100WQ80-15-7.5AC(I)	2940	100	<b>3 143.09</b>	2 189.96	2 308.75
100WQ100-15-7.5AC(I)	2940	100	<b>3 143.09</b>	2 189.96	2 308.75
100WQ80-25-11AC(I)	2940	100	<b>4 589.55</b>	3 636.43	3 755.22
100WQ100-30-15AC(I)	2940	100	<b>5 228.23</b>	4 275.11	4 385.51
150WQ100-7-5.5AC(I)	2940	150	<b>3 396.05</b>	1 671.47	1 906.26
150WQ100-10-5.5AC(I)	2940	150	<b>3 396.05</b>	1 671.47	1 906.26
150WQ100-17-7.5AC(I)	2940	150	<b>3 953.67</b>	2 229.09	2 463.88
150WQ150-10-7.5AC(I)	2940	150	<b>3 953.67</b>	2 229.09	2 463.88
150WQ120-25-15AC(I)	2930	150	<b>6 143.63</b>	4 419.05	4 653.84

Модель/арт. WQ с АТМ	Скорость, об/мин	DN	Цена розница WQ, USD с НДС		
			с АТМ	под гибкий шланг/ под АТМ	колесо с фланцем
<b>4-х полюсные</b>					
80WQ36-10-2.2AC(I)	1450	90	<b>2 181.58</b>	1 468.83	1 548.49

80WQ36-12-2.2AC(I)	1450	90	<b>2 181.58</b>	1 468.83	1 548.49
80WQ36-16-4AC(I)	1450	90	<b>2 435.93</b>	1 723.18	1 802.84
80WQ60-11-4AC(I)	1450	92	<b>2 435.93</b>	1 723.18	1 802.84
100WQ60-17-5.5AC(I)	1450	100	<b>3 092.78</b>	2 139.65	2 254.25
100WQ60-20-7.5AC(I)	1450	100	<b>3 308.00</b>	2 354.87	2 468.07
100WQ80-35-18.5AC(I)	1460	100	<b>6 277.79</b>	5 324.67	5 442.06
100WQ100-35-22AC(I)	1460	100	<b>6 035.76</b>	5 082.64	5 194.69
100WQ100-39-22AC(I)	1460	100	<b>6 035.76</b>	5 082.64	5 194.69
150WQ240-7-7.5AC(I)	1450	150	<b>3 953.67</b>	2 229.09	2 463.88
150WQ150-16-11AC(I)	1440	150	<b>5 689.43</b>	3 964.85	4 199.64
150WQ150-20-15AC(I)	1440	150	<b>6 143.63</b>	4 419.05	4 653.84
150WQ150-24-18.5AC(I)	1460	150	<b>7 170.83</b>	5 446.25	5 681.04
150WQ180-20-18.5AC(I)	1460	150	<b>7 170.83</b>	5 446.25	5 681.04
150WQ250-14-18.5AC(I)	1460	150	<b>7 170.83</b>	5 446.25	5 681.04
150WQ200-16-18.5AC(I)	1460	150	<b>7 170.83</b>	5 446.25	5 681.04
150WQ150-27-22AC(I)	1460	150	<b>7 499.77</b>	5 775.20	6 001.55
150WQ180-25-22AC(I)	1460	150	<b>7 499.77</b>	5 775.20	6 001.55
150WQ200-22-22AC(I)	1460	150	<b>7 499.77</b>	5 775.20	6 001.55
150WQ270-16-22AC(I)	1460	150	<b>7 499.77</b>	5 775.20	6 001.55
150WQ200-28-30AC(I)	1450	150	<b>по запросу</b>		
150WQ200-35-37AC(I)	1470	150			
150WQ150-35-37AC(I)	1470	150			
150WQ200-45-55AC(I)	1480	150			
150WQ270-40-55AC(I)	1480	150			
200WQ270-10-11AC(I)	1440	200	<b>6 242.86</b>	4 256.94	4 563.00
200WQ270-14-15AC(I)	1440	200	<b>6 657.93</b>	4 672.01	4 979.47
200WQ250-15-18.5AC(I)	1460	200	<b>7 618.05</b>	5 632.13	5 938.19
200WQ300-12-18.5AC(I)	1460	200	<b>7 618.05</b>	5 632.13	5 938.19
200WQ270-16-22AC(I)	1450	200	<b>7 940.89</b>	5 954.97	6 250.25
200WQ300-15-22AC(I)	1450	200	<b>7 940.89</b>	5 954.97	6 250.25
200WQ400-10-22AC(I)	1450	200	<b>7 940.89</b>	5 954.97	6 250.25
200WQ360-17-30AC(I)	1450	200	<b>по запросу</b>		
200WQ400-15-30AC(I)	1450	200			
200WQ250-22-30AC(I)	1450	200			
200WQ270-28-37AC(I)	1470	200			
200WQ300-26-37AC(I)	1450	200			
200WQ350-25-37AC(I)	1450	200			
200WQ400-25-45AC(I)	1470	200			
200WQ400-22-37AC(I)	1450	200			
200WQ250-40-55AC(I)	1450	200			
200WQ400-30-55AC(I)	1450	200			
200WQ350-40-75AC(I)	1450	200			
200WQ500-30-75AC(I)	1470	200			



250WQ400-15-30AC(I)	1460	250	по запросу		
250WQ600-9-30AC(I)	1450	250			
250WQ360-20-30AC(I)	1450	250			
250WQ420-22-37AC(I)	1470	250			
250WQ600-12-37AC(I)	1450	250			
250WQ360-28-45AC(I)	1470	250			
250WQ600-20-55AC(I)	1475	250			
250WQ600-28-75AC(I)	1450	250			
300WQ800-8-37AC(I)	1450	300			
300WQ500-15-37AC(I)	1450	300			
300WQ600-18-45AC(I)	1470	300			
300WQ800-12-45AC(I)	1450	300			
300WQ600-20-55AC(I)	1450	300			
300WQ800-20-75AC(I)	1450	300			
250WQ600-10-22-6AC(I)	983	250			
300WQ700-8-22-6AC(I)	983	300	22 119.65	17 950.76	--
300WQ800-9-30-6AC(I)	983	300	по запросу		
300WQ800-11-37-6AC(I)	983	300			
300WQ900-13-45-6AC(I)	983	300			
300WQ900-16-55-6AC(I)	983	300			
350WQ960-5.5-22-8AC(I)	734	350			
350WQ960-7-30-6AC(I)	983	350	по запросу		
350WQ1100-8-37-6AC(I)	983	350			
350WQ1200-29-132AC(I)	1471	350			
350WQ1200-33-150AC(I)	1490	350			
400WQ1600-6.5-45-6AC(I)	983	400			
400WQ1600-9-55-6AC(I)	983	400			
400WQ1200-16-75-6AC(I)	983	400			
400WQ1100-24-110-6AC(I)	984	400			
400WQ1600-22-132-6AC(I)	984	400			
400WQ1600-26-150-6AC(I)	984	400			
500WQ2000-9-75-6ACAC(I)	983	500			
500WQ2000-18-132-6AC(I)	983	500			
500WQ2000-20-150-6AC(I)	984	500			

### WQ\*JY с перемешивающим механизмом

Модель/арт. WQ с АТМ	Скорость, об/мин	DN	Цена розница WQ, USD с НДС		
			с АТМ	под гибкий	колено с
<b>2-х полюсные</b>					
50WQ9-7-0.55JYAC(I)	2850	40	990.86	603.74	652.66
50WQ12-10-0.75JYAC(I)	2850	40	990.86	603.74	652.66

50WQ7-15-1.1JYAC(I)	2850	40	<b>1 046.76</b>	659.64	698.78
50WQ15-15-1.5JYAC(I)	2880	50	<b>1 154.38</b>	767.25	817.57
50WQ15-18-2.2JYAC(I)	2880	50	<b>1 287.14</b>	900.02	947.54
50WQ15-25-3JYAC(I)	2840	50	<b>1 359.82</b>	972.69	1 020.21
50WQ15-32-4JYAC(I)	2840	50	<b>1 752.53</b>	1 365.41	1 414.32
50WQ15-38-5.5JYAC(I)	2940	50	<b>1 937.00</b>	1 549.88	1 598.80
65WQ15-10-1.1JYAC(I)	2850	65	<b>1 186.52</b>	659.64	723.93
65WQ25-9-1.5JYAC(I)	2850	65	<b>1 315.09</b>	788.22	852.51
65WQ25-13-2.2JYAC(I)	2880	65	<b>1 426.90</b>	900.02	962.91
65WQ35-9-2.2JYAC(I)	2880	65	<b>1 426.90</b>	900.02	962.91
65WQ25-18-3JYAC(I)	2840	65	<b>1 499.57</b>	972.69	1 035.58
65WQ20-27-4JYAC(I)	2840	65	<b>1 892.28</b>	1 365.41	1 429.69
65WQ25-30-5.5JYAC(I)	2940	65	<b>2 076.76</b>	1 549.88	1 614.17
65WQ35-50-11JYAC(I) ductile iron	2930	65	<b>3 719.68</b>	3 192.80	3 257.09
65WQ30-54-11JYAC(I) ductile iron	2930	65	<b>3 719.68</b>	3 192.80	3 257.09
80WQ40-10-2.2JYAC(I)	2880	80	<b>1 626.75</b>	914.00	996.45
80WQ35-13-3JYAC(I)	2840	80	<b>1 705.01</b>	992.26	1 074.72
80WQ40-15-4JYAC(I)	2840	80	<b>2 086.54</b>	1 373.79	1 456.25
80WQ40-22-5.5JYAC(I)	2940	80	<b>2 325.52</b>	1 612.77	1 695.23
80WQ40-30-7.5JYAC(I)	2940	80	<b>2 975.38</b>	2 262.63	2 345.09
80WQ50-29-11JYAC(I)	2930	80	<b>4 100.44</b>	3 387.69	3 470.14
100WQ50-7-2.2JYAC(I)	2880	100	<b>1 867.13</b>	914.00	1 032.79
100WQ50-10-3JYAC(I)	2840	100	<b>1 962.16</b>	1 009.03	1 127.82
100WQ50-12-4JYAC(I)	2840	100	<b>2 326.92</b>	1 373.79	1 492.58
100WQ75-12-4JYAC(I)	2840	100	<b>2 326.92</b>	1 373.79	1 492.58
100WQ65-15-5.5JYAC(I)	2940	100	<b>2 605.03</b>	1 651.90	1 769.30
100WQ70-18-7.5JYAC(I)	2940	100	<b>3 245.11</b>	2 291.98	2 409.38
100WQ100-15-7.5JYAC(I)	2940	100	<b>3 245.11</b>	2 291.98	2 409.38
100WQ100-22-11JYAC(I)	2930	100	<b>4 605.39</b>	3 652.26	3 771.06
100WQ100-30-15JYAC(I)	2930	100	<b>5 268.23</b>	4 315.10	4 433.89
100WQ100-35-22JYAC(I)	1460	100	<b>7 889.17</b>	6 936.04	7 049.43
150WQ100-10-7.5JYAC(I)	1450	150	<b>4 064.08</b>	2 339.50	2 574.29
150WQ140-10-7.5JYAC(I)	2900	150	<b>4 064.08</b>	2 339.50	2 574.29
150WQ150-13-11JYAC(I)	1440	150	<b>6 232.67</b>	4 508.10	4 742.89
150WQ140-24-15JYAC(I)	2930	150	<b>5 329.04</b>	3 604.47	3 839.26
150WQ150-19-15JYAC(I)	1440	150	<b>6 843.79</b>	5 119.21	5 354.00
150WQ200-17-18.5JYAC(I)	1460	150	<b>8 976.12</b>	7 251.54	7 486.33
150WQ250-15-18.5JYAC(I)	1460	150	<b>8 976.12</b>	7 251.54	7 486.33
150WQ150-25-22JYAC(I)	1460	150	<b>8 928.49</b>	7 203.91	7 428.03
150WQ300-16-22JYAC(I)	1460	150	<b>8 928.49</b>	7 203.91	7 428.03
200WQ210-11-11JYAC(I)	1440	200	<b>6 663.93</b>	4 678.01	4 983.28
200WQ300-11-15JYAC(I)	1440	200	<b>7 023.23</b>	5 037.32	5 342.58
200WQ300-13-18.5JYAC(I)	1460	200	<b>9 822.85</b>	7 836.93	8 142.19

## WQ-X погружные электронасосы для отвода канализационных сточных вод с Vortex колесом



обновление 15.02.2023

Модель/арт. WQX с ATM	Скорость, об/мин	DN	Цена розница WQ, USD с НДС		
			с ATM	под гибкий	колено с
50WQX10-8-0.75AC(I)	2840	50	<b>1 208.30</b>	821.18	890.24
50WQX12-10-1.5AC(I)	2840	50	<b>1 450.04</b>	1 062.91	1 131.98
65WQX25-9-1.5AC(I)	2840	65	<b>1 589.79</b>	1 062.91	1 162.20
80WQX35-9-2.2AC(I)	2840	80	<b>2 259.18</b>	1 546.43	1 697.52
80WQX50-12-4AC(I)	2840	80	<b>2 654.56</b>	1 941.80	2 092.89



## Погружные электронасосы WQ-W для отвода канализационных сточных вод с режущим механизмом

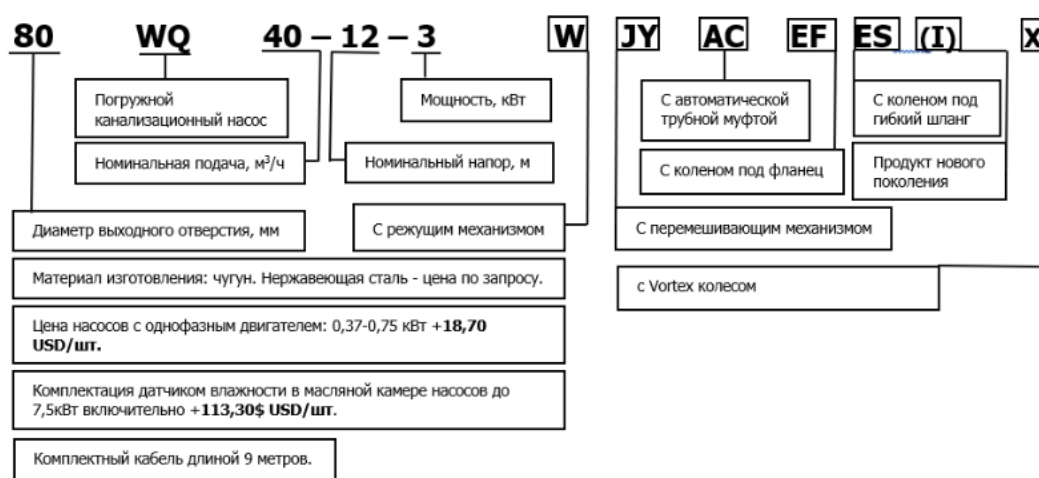

обновление  
15.02.2023

Модель/арт. WQ-W с ATM	Скорость, об/мин	DN	Цена розница WQ, USD с НДС		
			с ATM	под гибкий шланг/ под ATM	колено с фланцем
40WQ9-5-0.37ACW(I)	2800	40	<b>994.07</b>	658.54	698.50
40WQ10-7-0.55ACW(I)	2840	40	<b>996.45</b>	663.84	701.57
40WQ10-10-0.75ACW(I)	2840	40	<b>1 045.37</b>	712.75	753.28
40WQ12-15-1.5ACW(I)	2840	40	<b>1 255.00</b>	922.38	962.91
50WQ10-13-1.1ACW(I)	2840	50	<b>1 139.00</b>	751.88	799.40
50WQ10-7-0.55ACW(I)	2840	50	<b>1 050.96</b>	663.84	711.35
50WQ10-10-0.75ACW(I)	2840	50	<b>1 099.87</b>	712.75	761.66
50WQ12-15-1.5ACW(I)	2840	50	<b>1 309.50</b>	922.38	971.30

50WQ15-18-2.2ACW(I)	2840	50	<b>1 502.37</b>	1 115.24	1 164.16
50WQ15-25-3ACW(I)	2840	50	<b>1 735.76</b>	1 348.64	1 396.15
50WQ25-25-4ACW(I)	2840	50	<b>2 071.17</b>	1 684.05	1 734.36
50WQ18-32-5.5ACW(I)	2840	50	<b>2 359.06</b>	1 971.94	2 020.86
65WQ15-10-1.1ACW(I)	2840	65	<b>1 278.76</b>	751.88	816.17
65WQ25-10-1.5ACW(I)	2840	65	<b>1 449.26</b>	922.38	986.67
65WQ25-14-2.2ACW(I)	2840	65	<b>1 642.12</b>	1 115.24	1 179.53
65WQ25-18-3ACW(I)	2840	65	<b>1 875.51</b>	1 348.64	1 412.92
65WQ40-16-4ACW(I)	2840	65	<b>2 210.92</b>	1 684.05	1 748.34
65WQ30-25-5.5ACW(I)	2840	65	<b>2 598.05</b>	2 071.17	2 135.46
65WQ45-28-7.5ACW(I)	2840	65	<b>3 144.49</b>	2 617.61	2 676.31
80WQ40-8-2.2ACW(I)	2840	80	<b>1 882.50</b>	1 169.75	1 253.60
80WQ35-13-3ACW(I)	2840	80	<b>2 128.47</b>	1 415.72	1 498.17
80WQ40-22-5.5ACW(I)	2840	80	<b>2 881.75</b>	2 169.00	2 251.45
80WQ50-12-4ACW(I)	2840	80	<b>2 480.65</b>	1 767.90	1 850.36
100WQ50-10-3ACW(I)	2840	100	<b>2 435.93</b>	1 482.80	1 565.26
100WQ60-11-4ACW(I)	2840	100	<b>2 804.88</b>	1 851.75	1 971.94
100WQ65-15-5.5ACW(I)	2840	100	<b>3 338.75</b>	2 385.62	2 505.81
100WQ70-17-7.5ACW(I)	2840	100	<b>3 421.20</b>	2 468.07	2 588.26
150WQ140-10-7.5ACW(I)	2840	150	<b>4 368.74</b>	2 644.16	2 880.35
150WQ140-14-11ACW(I)	1440	150	<b>5 879.49</b>	4 154.92	4 389.70
150WQ200-16-15ACW(I)	1440	150	<b>6 402.18</b>	4 677.60	4 913.79
200WQ210-10-11ACW(I)*	1440	200	<b>6 472.06</b>	4 486.14	4 781.02
200WQ300-10-15ACW(I)*	1440	200	<b>6 909.49</b>	4 923.57	6 793.49

## Погружные однофазные электронасосы WQ-D для отвода канализационных сточных вод

обновление  
15.02.2023

Модель/арт. WQD с АТМ	Материал	Мощность, кВт	Скорость, об/мин	Цена розница, USD с НДС		
				с АТМ	под гибкий шланг/ под АТМ	колесо с фланцем
40WQD12-10-0.75AC(I)	HT200/GG20	1	2850	1 017.40	684.78	746.82
40WQD12-18-1.5AC(I)	HT200/GG20	2	2880	1 259.19	926.58	988.61
50WQD10-15-1.5AC(I)	HT200/GG20	2	2880	1 313.70	926.58	1027.13
50WQD10-18-1.5AC(I)	HT200/GG20	2	2880	1 313.70	926.58	1027.13
50WQD12-10-0.75AC(I)	HT200/GG20	1	2850	1 074.24	687.12	787.68
50WQD12-12-1.5AC(I)	HT200/GG20	2	2880	1 313.70	926.58	1027.13
50WQD15-10-1.5AC(I)	HT200/GG20	2	2880	1 313.70	926.58	1027.13
50WQD15-15-1.5AC(I)	HT200/GG20	2	2880	1 302.53	915.41	1015.97
50WQD15-18-2.2AC(I)	HT200/GG20	2	2880	1 467.24	1 080.12	1180.68
50WQD15-20-2.2AC(I)	HT200/GG20	2	2880	1 454.89	1 067.77	1168.33
50WQD20-15-2.2AC(I)	HT200/GG20	2	2880	1 467.24	1 080.12	1180.68
50WQD25-10-2.2AC(I)	HT200/GG20	2	2880	1 467.24	1 080.12	1180.68
50WQD9-22-2.2AC(I)	HT200/GG20	2	2880	1 467.24	1 080.12	1180.68
65WQD25-10-1.5AC(I)	HT200/GG20	2	2850	1 607.00	1 080.12	1180.68
65WQD25-14-2.2AC(I)	HT200/GG20	2	2880	1 714.08	1 187.21	1287.77
65WQD35-7-2.2AC(I)	HT200/GG20	2	2880	1 700.54	1 173.66	1274.22
80WQD40-10-2.2AC(I)	HT200/GG20	2	2880	1 951.71	1 238.96	1389.78
80WQD40-8-2.2AC(I)	HT200/GG20	2	2880	1 951.71	1 238.96	1389.78
80WQD45-9-2.2AC(I)	HT200/GG20	2	2880	1 951.71	1 238.96	1389.78
100WQD50-7-2.2AC(I)	HT200/GG20	2	2880	2 419.77	1 466.64	1633.50

Цена указана для напряжения 1x220В, при необходимости комплектации электродвигателем под другое напряжения цена увеличивается на 5%.

## Погружные электронасосы WQ Н для отвода канализационных сточных вод

обновление 15.02.2023

Комплектация насосов серии WQ ATM		
Модель ATM	Применяется для	Примечание
TOS-40~150 TO-150~500	Насосы WQ мощностью более 0.55 кВт (за исключением 4-х полюсных моделей DN100 мощностью 18.5-22 кВт и насосов серии WQ-Н).	Стандартная автоматическая трубная муфта
TOS-80F TOS-100F	4-х полюсные насосы с напорным патрубком DN100 и мощностью 18.5-22 кВт (например, 100WQ100-39-22AC(I); насосы серии WQ-Н.	Усиленная автоматическая трубная муфта

**Особенности:** высокий напор, спиральное рабочее колесо, высокая эффективность, конструкция для более тяжелых условий эксплуатации

Модель	Скорость, об/мин	Материал	Мощность, кВт	Цена розница WQ, USD с НДС		
				с ATM	под гибкий шланг/ под ATM	колесо с фланцем
80WQ60-28-11H(I)	1440	HT200/GG20	11	<b>5 784.52</b>	5 071.77	7 965.59
80WQ60-35-15H(I)	1440	HT200/GG20	15	<b>5 850.39</b>	5 137.64	7 969.12
80WQ60-40-18.5H(I)	1460	HT200/GG20	18.5	<b>7 904.74</b>	7 191.99	12 857.91
80WQ80-43-22H(I)	1460	HT200/GG20	22	<b>7 901.79</b>	7 189.04	
100WQ100-22-11H(I)	1440	HT200/GG20	11	<b>5 896.63</b>	4 943.50	7 796.16
100WQ100-29-15H(I)	1440	HT200/GG20	15	<b>5 896.63</b>	4 943.50	7 796.16
100WQ100-32-18.5H(I)	1460	HT200/GG20	18.5	<b>7 949.79</b>	6 996.66	12 683.19
100WQ100-34-22H(I)	1460	HT200/GG20	22	<b>7 949.22</b>	6 996.09	



**Примечание:**

Цена указана на насосы с подключением 380В, отличное от стандартного +5% к розничной цене

**Топ версия:** механическое уплотнение: Burgmann, маслоподъемник: Япония

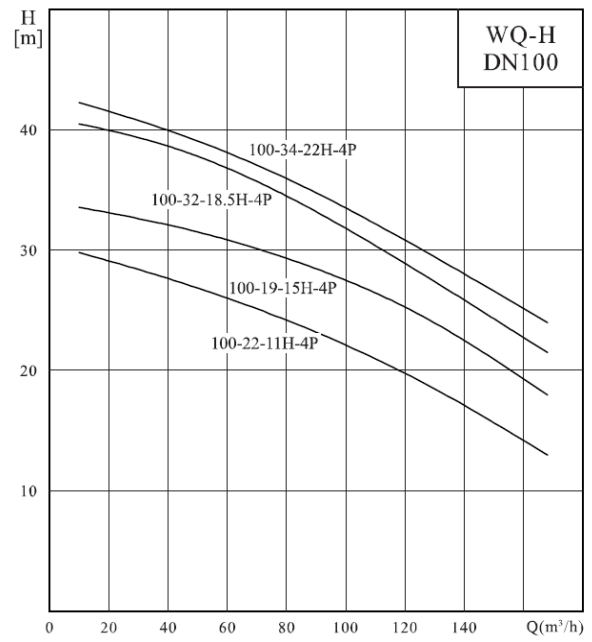
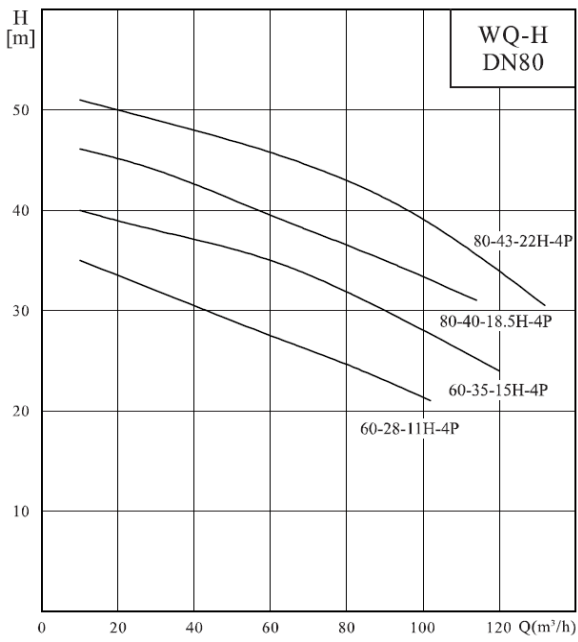
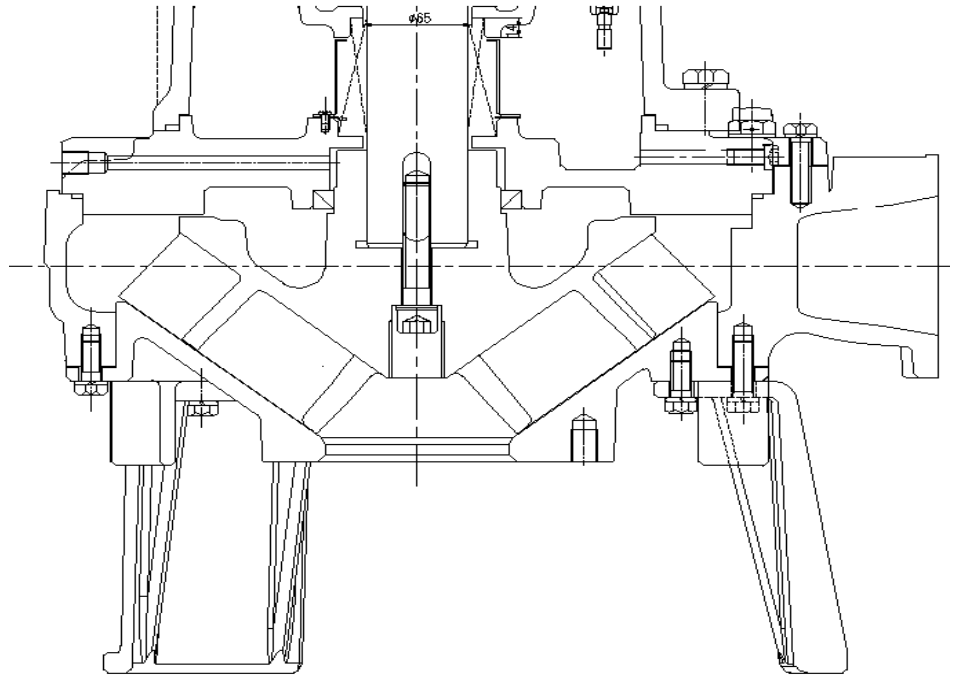
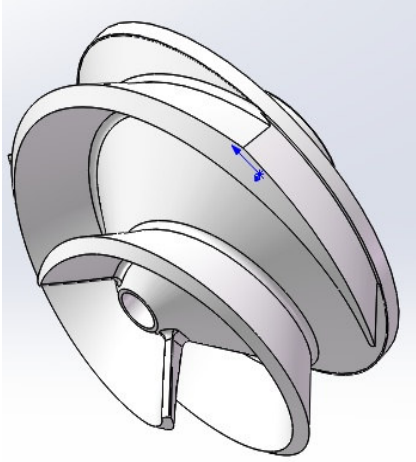





## Погружные электронасосы WQ-QG для отвода канализационных сточных вод с режущим механизмом

обновление  
15.02.2023

Модель/арт. WQ-QG с АТМ	Скорость, об/мин	DN	Цена розница WQ, USD с НДС		
			с АТМ	под гибкий шланг/ под АТМ	колено с фланцем
32WQ6-20-1.1/QG(I)	2850	32		737.34	796.57
50WQ10-10-0.75/QG(I)	2850	50	1 086.26	699.14	766.53
50WQ10-15-1.1/QG(I)	2850	50	1 124.46	737.34	804.73
50WQ15-15-1.5/ QG(I)	2880	50	1 292.34	905.22	972.61
50WQ15-20-2.2/QG(I)	2880	50	1 482.17	1 095.04	1 162.43
50WQ15-28-3/QG(I)	2840	50	1 710.73	1 323.61	1 391.00
50WQ25-27-4/QG(I)	2840	50	2 041.48	1 654.36	1 721.75
80WQ25-15-2.2/QG(I)	2880	80	2 218.31	1 505.56	1 649.52
80WQ40-12-3/QG(I)	2840	80	2 162.72	1 449.96	1 593.92
80WQ40-17-4/QG(I)	2840	80	2 367.11	1 654.36	1 798.32
80WQ50-22-5.5/QG(I)	2940	80	2 844.42	2 131.67	2 275.63
80WQ45-29-7.5/QG(I)	2940	80	3 266.18	2 553.43	2 697.39
80WQ35-40-11/QG(I)	2930	80	4 949.18	4 236.43	4 380.39
80WQ36-10-2.2/QG(I)	1413	80	2 337.33	1 624.58	1 768.54
80WQ60-11-4/QG(I)	1413	80	2 581.06	1 868.31	2 012.27

## Принадлежности для насосов всех серий WQ

### Автоматическая трубная муфта для насосов WQ (WQ-W)

Комплектация насосов серии WQ ATM		
Модель ATM	Применяется для	Примечание
TOS-40~150 TO-150~500	Насосы WQ мощностью более 0.55 кВт (за исключением 4-х полюсных моделей DN100 мощностью 18.5-22 кВт и насосов серии WQ-H).	Стандартная автоматическая трубная муфта
TOS-80F TOS-100F	4-х полюсные насосы с напорным патрубком DN100 и мощностью 18.5-22 кВт (например, 100WQ100-39-22AC(I); насосы серии WQ-H).	Усиленная автоматическая трубная муфта

Наименование	Артикул	Цена розн., USD/шт., с НДС
Автоматическая трубная муфта DN40	TOS-40	<b>332.62</b>
Автоматическая трубная муфта DN50	TOS-50	<b>387.12</b>
Автоматическая трубная муфта DN65	TOS-65	<b>526.88</b>
Автоматическая трубная муфта DN80	TOS-80	<b>712.75</b>
Автоматическая трубная муфта DN100	TOS-100	<b>953.13</b>
Автоматическая трубная муфта DN150 (до 22 кВт)	TOS-150	<b>1 724.58</b>
Автоматическая трубная муфта DN150 (свыше 30 кВт)	TO-150	<b>1 724.58</b>
Автоматическая трубная муфта DN200	TO-200	<b>1 985.92</b>
Автоматическая трубная муфта DN250	TO-250	<b>2 751.78</b>
Автоматическая трубная муфта DN300	TO-300	<b>4 168.89</b>



### Поплавковый датчик уровня (канализация)

Наименование	Артикул	Цена розн., USD/шт., с НДС
Поплавковый датчик уровня FS-1-10 для канализации (кабель 10 м)	FS-1-10	<b>86.39</b>
Поплавковый датчик уровня FS-1-20 для канализации (кабель 20 м)	FS-1-20	<b>121.97</b>

### Поплавковый датчик уровня (чистая вода)



Наименование	Артикул	Цена розн., USD/шт., с НДС
Поплавковый датчик уровня FS-2-7 для чистой воды (кабель 7 м)	FS-2-7	<b>23.96</b>
Поплавковый датчик уровня FS-2-10 для чистой воды (кабель 10 м)	FS-2-10	<b>30.61</b>

### Датчики для WQ

Наименование	Цена розн., USD/шт.,с НДС
Датчик протечки воды в масляную камеру WQ(W) для насосов мощность до 7,5кВт включительно	<b>54.50</b>
Датчик температуры двигателя РТ100 для Р>30кВт	<b>26.55</b>

### Комплектный кабель для WQ (отгрузка кратно 5 метрам)

Мощность, кВт	Сечение кабеля, мм2	Цена USD, с НДС		Сечение кабеля, мм2	+ к стоимости прямого пуска	Цена USD, с НДС	
		кабель (\$/пог.м.)	крышка гермоввода (\$/шт)			кабель (\$/пог.м.)	крышка гермоввода (\$/шт)
прямой пуск				звезда/треугольник			
0.55~1.1	4×0.75	<b>5.64</b>	<b>9.53</b>	-	-	-	-
1.5~2.2	4×1	<b>7.19</b>	<b>14.32</b>	-	-	-	-
3~4	4×1.5	<b>9.96</b>	<b>14.32</b>	-	-	-	-
5.5~7.5	4×2.5	<b>14.22</b>	<b>14.32</b>	-	-	-	-
11	4×4	<b>22.73</b>	<b>19.75</b>	4×2.5+3×2.5	<b>221.96</b>	<b>36.95</b>	<b>300.97</b>
15	4×6	<b>31.89</b>	<b>19.75</b>	4×2.5+3×2.5	<b>221.96</b>	<b>46.11</b>	<b>300.97</b>
18.5~22	4×10	<b>53.29</b>	<b>55.64</b>	4×6+3×6	<b>304.75</b>	<b>85.18</b>	<b>527.29</b>
30	4×16	<b>73.47</b>	<b>86.36</b>	4×6+3×6	<b>304.75</b>	<b>105.36</b>	<b>650.17</b>
37	4×25	<b>114.15</b>	<b>86.36</b>	4×10+3×10	<b>529.58</b>	<b>167.44</b>	<b>875.00</b>
-	-	-	-	4×10+3×10	<b>529.58</b>	<b>167.44</b>	<b>875.00</b>
-	-	-	-	4×16+3×16	<b>529.58</b>	<b>187.62</b>	<b>875.00</b>
-	-	-	-	4×25+3×25	<b>529.58</b>	<b>228.29</b>	<b>875.00</b>



## Компактные канализационные насосные станции NPW

В комплект поставки входит канализационная насосная станция (бак, насос(ы), АТМ, обратный клапан, выходной патрубок с уплотнением, воздушный клапан с уплотнением, датчик уровня, кабель и кабельный ввод) и контроллер.

**обновление**  
**15.02.2023**

Модель/арт.	Мощность, кВт	Питание, В	Объем бака, л	DN	Цена розница USD с НДС
<b>Бак 100 литров</b>					
WQ NPWG10-10-0.75-110S	0.75	3x380	100	50	<b>4 902.64</b>
WQ NPWG10-13-1.1-110S	1.10	3x380	100	50	<b>5 104.52</b>
<b>Бак 180 литров</b>					
WQ NPWG10-10-0.75-180S	0.75	3x380	180	50	<b>5 672.89</b>
WQ NPWG10-13-1.1-180S	1.10	3x380	180	50	<b>5 874.78</b>
WQ NPWG15-15-1.5-180S	1.50	3x380	180	50	<b>6 216.42</b>
WQ NPWG18-20-2.2-180S	2.20	3x380	180	50	<b>6 495.95</b>
<b>Бак 300 литров</b>					
WQ NPWG10-10-0.75-300D	2x0.75	3x380	300	50	<b>8 904.82</b>
WQ NPWG10-13-1.1-300D	2x1.1	3x380	300	50	<b>9 241.29</b>
WQ NPWG15-15-1.5-300D	2x1.5	3x380	300	50	<b>9 810.71</b>
WQ NPWG18-20-2.2-300D	2x2.2	3x380	300	50	<b>10 276.59</b>
WQ NPWG20-24-3-300D	2x3.0	3x380	300	50	<b>10 690.71</b>
<b>Бак 450 литров</b>					
WQ NPWG10-10-0.75-500D	2x0.75	3x380	450	50	<b>9 680.00</b>
WQ NPWG10-13-1.1-500D	2x1.1	3x380	450	50	<b>10 016.47</b>
WQ NPWG15-15-1.5-500D	2x1.5	3x380	450	50	<b>10 585.88</b>
WQ NPWG18-20-2.2-500D	2x2.2	3x380	450	50	<b>11 051.76</b>
WQ NPWG20-24-3-500D	2x3.0	3x380	450	50	<b>11 465.88</b>
<b>Бак 900 литров</b>					
WQ NPWG10-10-0.75-1000D	2x0.75	3x380	900	50	<b>11 905.88</b>
WQ NPWG10-13-1.1-1000D	2x1.1	3x380	900	50	<b>12 175.06</b>
WQ NPWG15-15-1.5-1000D	2x1.5	3x380	900	50	<b>12 630.59</b>
WQ NPWG18-20-2.2-1000D	2x2.2	3x380	900	50	<b>13 003.29</b>
WQ NPWG20-24-3-1000D	2x3.0	3x380	900	50	<b>13 334.59</b>



## SDS погружные дренажные насосы

В цену моделей SDS MF и SDS F включена стоимость поплавкового датчика уровня и кабеля длиной 8 м.

Для моделей со \* предоставляется дополнительная скидка на заказ партиями: от 3 шт включительно - 15%, от 5 шт включительно - 25%.

обновление  
15.02.2023

Модель/артикул	Питающее напряжение, В	Частота вращения, об/мин	Мощность, кВт	Напорный патрубок, мм	Цена розница (USD) с НДС
SDS MF2.25	1x220	2850	0,25	50	651.33
SDS MF2.4	1x220	2850	0,4	50	684.67
SDS MF2.75	1x220	2850	0,75	50	746.00
SDS MF21.5*	1x220	2850	1,5	50	1 650.00
SDS MF31.5*	1x220	2850	1,5	80	1 661.00
SDS 21.5*	3x400	2850	1,5	50	1 595.00
SDS F21.5*	3x400	2850	1,5	50	1 925.00
SDS 31.5*	3x400	2850	1,5	80	1 606.00
SDS F31.5*	3x400	2850	1,5	80	1 936.00
SDS 22.2*	3x400	2850	2,2	50	1 815.00
SDS F22.2*	3x400	2850	2,2	50	2 132.90
SDS F32.2*	3x400	2850	2,2	80	2 211.00
SDS 32.2*	3x400	2850	2,2	80	1 993.20
SDS 23.7*	3x400	2850	3,7	50	3 080.00
SDS F23.7*	3x400	2850	3,7	50	3 311.00
SDS 33.7*	3x400	2850	3,7	80	3 174.60
SDS F33.7*	3x400	2850	3,7	80	3 430.90
SDS 43.7*	3x400	2850	3,7	100	3 180.10
SDS F43.7*	3x400	2850	3,7	100	3 631.10
SDS 35.5*	3x400	2850	5,5	80	3 894.00
SDS F35.5*	3x400	2850	5,5	80	4 323.00
SDS 45.5*	3x400	2850	5,5	100	4 224.00
SDS F45.5*	3x400	2850	5,5	100	4 554.00
SDS 47.5*	3x400	2850	7,5	100	5 453.80
SDS 67.5*	3x400	2850	7,5	150	5 436.20

SDS 411*	3x400	2850	11	100	<b>7 106.00</b>
SDS 611*	3x400	2850	11	150	<b>7 309.50</b>



## NES АГРЕГАТЫ ЭЛЕКТРОНАСОСНЫЕ КОНСОЛЬНО-МОНОБЛОЧНЫЕ по стандарту EN733

**NES(0) 100 - 80 - 320(300) - 18,5/ 2 x x x**

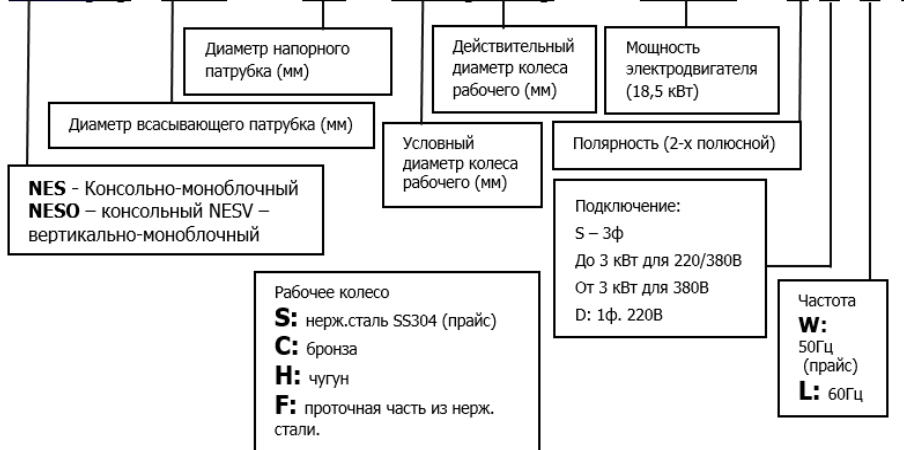

Цены указаны для насосов NES следующего конструктива:  
Насосная часть - чугун, рабочее колесо - чугун, торцевое уплотнение, вал - нерж. сталь (CI-CI-SS-MS)  
Стоимость насоса вертикальной установки: до 45кВт +15%, свыше 45кВт +10% к прайсовой цене

обновление 15.02.2023

Насосные агрегаты комплектуются двигателями с классом защиты IP55 в стандартном исполнении (по цене агрегата с двигателем IP54)!!!

Модель агрегата	Мощность, кВт	Цена розница USD с НДС	Артикул
-----------------	---------------	------------------------	---------

Модель агрегата	Мощность, кВт	Цена розница USD с НДС	Артикул
-----------------	---------------	------------------------	---------

2-х полюсные, 50Гц, 2900 об/мин

50-32-130	2.2	870.38	NES50-32-130-2.2/2SWH
	1.5	839.85	NES50-32-130-1.5/2SWH
	1.1	770.29	NES50-32-130-1.1/2SWH
50-32-160	5.5	1 106.73	NES50-32-160-5.5/2SWH
	4	1 106.73	NES50-32-160-4/2SWH
	3	1 034.33	NES50-32-160-3/2SWH
50-32-200	2.2	917.50	NES50-32-160-2.2/2SWH
	1.5	887.44	NES50-32-160-1.5/2SWH
	11	1 995.70	NES50-32-200-11/2SWH
50-32-260	7.5	1 502.76	NES50-32-200-7.5/2SWH
	5.5	1 451.87	NES50-32-200-5.5/2SWH
	4	1 343.35	NES50-32-200-4/2SWH
65-40-130	18.5	2 501.17	NES50-32-260-18.5/2SWH
	15	2 348.52	NES50-32-260-15/2SWH
	11	2 346.14	NES50-32-260-11/2SWH
65-40-160	4	1 077.46	NES65-40-130-4/2SWH
	3	982.56	NES65-40-130-3/2SWH
	2.2	885.98	NES65-40-130-2.2/2SWH
65-40-200	1.5	856.70	NES65-40-130-1.5/2SWH
	7.5	1 634.15	NES65-40-160-7.5/2SWH
	5.5	1 615.99	NES65-40-160-5.5/2SWH
65-40-260	4	1 255.96	NES65-40-160-4/2SWH
	3	1 207.48	NES65-40-160-3/2SWH
	11	2 192.62	NES65-40-200-11/2SWH

80-65-130	5.5	1 388.15	NES80-65-130-5.5/2SWH
	4	1 192.49	NES80-65-130-4/2SWH
	11	2 150.30	NES80-65-130-11/2SWH
80-65-160	7.5	1 497.70	NES80-65-130-7.5/2SWH
	18.5	2 519.09	NES80-65-160-18.5/2SWH
	15	2 366.45	NES80-65-160-15/2SWH
80-65-200H	11	2 274.86	NES80-65-160-11/2SWH
	7.5	1 872.72	NES80-65-160-7.5/2SWH
	30	3 510.28	NES80-65-200H-30/2SWH
80-65-260	22	2 853.17	NES80-65-200H-22/2SWH
	18.5	2 430.91	NES80-65-200H-18.5/2SWH
	15	2 278.26	NES80-65-200H-15/2SWH
80-65-320H	55	по запросу	NES80-65-260-55/2SWH
	45	4 422.79	NES80-65-260-45/2SWH
	37	3 787.99	NES80-65-260-37/2SWH
100-80-160	30	3 548.84	NES80-65-260-30/2SWH
	90	по запросу	NES80-65-320H-90/2SWH
	75	по запросу	NES80-65-320H-75/2SWH
100-80-260	55	6 773.92	NES80-65-320H-55/2SWH
	45	6 773.92	NES80-65-320H-45/2SWH
	30	3 429.92	NES100-80-160-30/2SWH
100-80-320	22	2 934.09	NES100-80-160-22/2SWH
	18.5	2 369.59	NES100-80-160-18.5/2SWH
	11	2 126.10	NES100-80-160-11/2SWH



65-40-200	7.5	1 526.92	NES65-40-200-7.5/2SWH
	5.5	1 476.04	NES65-40-200-5.5/2SWH
65-40-260	22	3 143.61	NES65-40-260-22/2SWH
	18.5	2 615.41	NES65-40-260-18.5/2SWH
	15	2 321.38	NES65-40-260-15/2SWH
65-40-320H	45	5 148.07	NES65-40-320H-45/2SWH
	37	4 507.44	NES65-40-320H-37/2SWH
	30	4 219.48	NES65-40-320H-30/2SWH
	22	3 516.09	NES65-40-320H-22/2SWH
65-50-130	7.5	1 382.91	NES65-50-130-7.5/2SWH
	5.5	1 332.03	NES65-50-130-5.5/2SWH
	3	1 041.33	NES65-50-130-3/2SWH
	4	1 116.87	NES65-50-130-4/2SWH
65-50-160	11	2 061.45	NES65-50-160-11/2SWH
	7.5	1 455.36	NES65-50-160-7.5/2SWH
	5.5	1 404.47	NES65-50-160-5.5/2SWH
65-50-200	18.5	2 366.66	NES65-50-200-18.5/2SWH
	15	2 214.01	NES65-50-200-15/2SWH
	11	2 223.86	NES65-50-200-11/2SWH
	7.5	2 122.42	NES65-50-200-7.5/2SWH
65-50-260H	37	4 330.69	NES65-50-260H-37/2SWH
	30	4 042.73	NES65-50-260H-30/2SWH
	22	2 933.58	NES65-50-260H-22/2SWH
65-50-320H	75	по запросу	NES65-50-320H-75/2SWH
	55	по запросу	NES65-50-320H-55/2SWH
	45	5 123.50	NES65-50-320H-45/2SWH
	37	4 512.69	NES65-50-320H-37/2SWH
	30	4 254.03	NES65-50-320H-30/2SWH

100-80-200	15	2 216.94	NES100-80-160-15/2SWH
	45	4 451.06	NES100-80-200-45/2SWH
	37	3 884.83	NES100-80-200-37/2SWH
	30	3 645.68	NES100-80-200-30/2SWH
100-80-260	22	3 004.73	NES100-80-200-22/2SWH
	75	по запросу	NES100-80-260-75/2SWH
	55	по запросу	NES100-80-260-55/2SWH
	45	4 708.89	NES100-80-260-45/2SWH
100-80-320H	132	по запросу	NES100-80-320H-132/2SWH
	110	по запросу	NES100-80-320H-110/2SWH
	90	по запросу	NES100-80-320H-90/2SWH
	75	по запросу	NES100-80-320H-75/2SWH
125-100-160	30	4 221.44	NES125-100-160-30/2SWH
	22	3 516.09	NES125-100-160-22/2SWH
	18.5	3 088.59	NES125-100-160-18.5/2SWH
	15	2 948.83	NES125-100-160-15/2SWH
125-100-200	75	по запросу	NES125-100-200-75/2SWH
	55	по запросу	NES125-100-200-55/2SWH
	45	4 619.35	NES125-100-200-45/2SWH
	37	4 067.35	NES125-100-200-37/2SWH
	30	3 808.32	NES125-100-200-30/2SWH
125-100-260	110	по запросу	NES125-100-260-110/2SWH
	132	по запросу	NES125-100-260-132/2SWH
	90	по запросу	NES125-100-260-90/2SWH
	75	по запросу	NES125-100-260-75/2SWH
150-125-200	90	по запросу	NES150-125-200-90/2SWH
	75	по запросу	NES150-125-200-75/2SWH
	55	по запросу	NES150-125-200-55/2SWH
	45	7 457.33	NES150-125-200-45/2SWH
125-100-320	132	по запросу	NES125-100-320-132/2SWH
	110	по запросу	NES125-100-320-110/2SWH
	90	по запросу	NES125-100-320-90/2SWH
150-125-260	200	по запросу	NES150-125-260-200/2SWH
	132	по запросу	NES150-125-260-132/2SWH
	110	по запросу	NES150-125-260-110/2SWH
	90	по запросу	NES150-125-260-90/2SWH

Модель агрегата	Мощность, кВт	Цена розница USD с НДС	Артикул
-----------------	---------------	------------------------	---------

Модель агрегата	Мощность, кВт	Цена розница USD с НДС	Артикул
-----------------	---------------	------------------------	---------

4-х полюсные, 50Гц, 1450об/мин

50-32-130	0.55	744.85	NES50-32-130-0.55/4SWH
	0,37(0,55)	744.85	NES50-32-130-0.37(0.55)/4SWH
50-32-160	0.55	807.47	NES50-32-160-0.55/4SWH
50-32-200	1.1	1 090.33	NES50-32-200-1.1/4SWH
	0.75	945.25	NES50-32-200-0.75/4SWH
	0.55	917.30	NES50-32-200-0.55/4SWH
50-32-260	3	1 397.11	NES50-32-260-3/4SWH
	2.2	1 351.32	NES50-32-260-2.2/4SWH
	1.5	1 241.06	NES50-32-260-1.5/4SWH
65-40-130	0.55	760.59	NES65-40-130-0.55/4SWH
	0,37(0,55)	760.59	NES65-40-130-0.37(0.55)/4SWH
65-40-160	1.1	1 020.49	NES65-40-160-1.1/4SWH
	0.75	859.07	NES65-40-160-0.75/4SWH
	0.55	838.71	NES65-40-160-0.55/4SWH
65-40-200	1.5	1 064.42	NES65-40-200-1.5/4SWH
	0.75	1 008.51	NES65-40-200-0.75/4SWH
	1.1	1 038.97	NES65-40-200-1.1/4SWH
65-40-260	3	1 369.97	NES65-40-260-3/4SWH
	1.5	1 254.29	NES65-40-260-1.5/4SWH
	2.2	1 324.17	NES65-40-260-2.2/4SWH
65-40-320	7.5	2 161.00	NES65-40-320-7.5/4SWH
	5.5	2 032.50	NES65-40-320-5.5/4SWH
	4	1 823.80	NES65-40-320-4/4SWH
65-50-130	1.1	891.43	NES65-50-130-1.1/4SWH
	0.55	800.72	NES65-50-130-0.55/4SWH
65-50-160	1.5	962.73	NES65-50-160-1.5/4SWH
	1.1	937.29	NES65-50-160-1.1/4SWH
	0.75	882.44	NES65-50-160-0.75/4SWH

125-100-160	4	1 695.23	NES125-100-160-4/4SWH
	2.2	1 373.79	NES125-100-160-2.2/4SWH
	3	1 415.72	NES125-100-160-3/4SWH
125-100-200	11	2 458.89	NES125-100-200-11/4SWH
	7.5	2 079.26	NES125-100-200-7.5/4SWH
	5.5	1 967.32	NES125-100-200-5.5/4SWH
125-100-260	4	1 728.82	NES125-100-200-4/4SWH
	15	2 893.12	NES125-100-260-15/4SWH
	11	2 689.59	NES125-100-260-11/4SWH
125-100-320	22	3 535.80	NES125-100-320-22/4SWH
	30	4 374.33	NES125-100-320-30/4SWH
	18.5	3 382.92	NES125-100-320-18.5/4SWH
125-100-400	15	3 037.41	NES125-100-320-15/4SWH
	45	6 160.43	NES125-100-400-45/4SWH
	37	5 817.27	NES125-100-400-37/4SWH
	30	5 432.76	NES125-100-400-30/4SWH
150-125-200	22	4 594.23	NES125-100-400-22/4SWH
	11	3 589.82	NES150-125-200-11/4SWH
	7.5	2 240.45	NES150-125-200-7.5/4SWH
	22	3 506.45	NES150-125-260-22/4SWH
150-125-260	30	4 344.98	NES150-125-260-30/4SWH
	18.5	3 341.57	NES150-125-260-18.5/4SWH
	15	2 996.67	NES150-125-260-15/4SWH
150-125-320	30	5 567.78	NES150-125-320-30/4SWH
	22	4 721.12	NES150-125-320-22/4SWH
	18.5	4 583.74	NES150-125-320-18.5/4SWH
	15	4 038.92	NES150-125-320-15/4SWH
150-125-400	75	по запросу	NES150-125-400-75/4SWH



<b>65-50-200</b>	2.2	<b>1 190.08</b>	NES65-50-200-2.2/4SWH
	1.1	<b>1 122.23</b>	NES65-50-200-1.1/4SWH
	1.5	<b>1 147.39</b>	NES65-50-200-1.5/4SWH
<b>65-50-260</b>	5.5	<b>1 779.68</b>	NES65-50-260-5.5/4SWH
	4	<b>1 480.79</b>	NES65-50-260-4/4SWH
	3	<b>1 404.14</b>	NES65-50-260-3/4SWH
<b>65-50-320</b>	11	<b>2 664.59</b>	NES65-50-320-11/4SWH
	7.5	<b>2 193.24</b>	NES65-50-320-7.5/4SWH
	5.5	<b>2 081.29</b>	NES65-50-320-5.5/4SWH
<b>80-65-130</b>	1.5	<b>973.07</b>	NES80-65-130-1.5/4SWH
	0.75	<b>912.68</b>	NES80-65-130-0.75/4SWH
	1.1	<b>947.62</b>	NES80-65-130-1.1/4SWH
<b>80-65-160</b>	2.2	<b>1 158.84</b>	NES80-65-160-2.2/4SWH
	1.5	<b>1 418.41</b>	NES80-65-160-1.5/4SWH
	1.1	<b>1 376.59</b>	NES80-65-160-1.1/4SWH
<b>80-65-200</b>	4	<b>1 376.45</b>	NES80-65-200-4/4SWH
	3	<b>1 300.13</b>	NES80-65-200-3/4SWH
	2.2	<b>1 254.33</b>	NES80-65-200-2.2/4SWH
<b>80-65-260</b>	7.5	<b>2 043.73</b>	NES80-65-260-7.5/4SWH
	5.5	<b>1 931.79</b>	NES80-65-260-5.5/4SWH
	3	<b>1 625.14</b>	NES80-65-260-3/4SWH
	4	<b>1 695.01</b>	NES80-65-260-4/4SWH
<b>80-65-320</b>	15	<b>2 979.27</b>	NES80-65-320-15/4SWH
	11	<b>2 691.64</b>	NES80-65-320-11/4SWH
	7.5	<b>2 271.88</b>	NES80-65-320-7.5/4SWH
<b>100-80-160</b>	3	<b>1 264.09</b>	NES100-80-160-3/4SWH
	2.2	<b>1 218.30</b>	NES100-80-160-2.2/4SWH
	1.5	<b>1 148.42</b>	NES100-80-160-1.5/4SWH
<b>100-80-200</b>	7.5	<b>1 893.68</b>	NES100-80-200-7.5/4SWH
	5.5	<b>1 795.88</b>	NES100-80-200-5.5/4SWH
	3	<b>1 501.29</b>	NES100-80-200-3/4SWH
	4	<b>1 557.20</b>	NES100-80-200-4/4SWH
<b>100-80-260</b>	11	<b>2 576.64</b>	NES100-80-260-11/4SWH
	7.5	<b>2 163.53</b>	NES100-80-260-7.5/4SWH
	5.5	<b>2 051.59</b>	NES100-80-260-5.5/4SWH
<b>100-80-320</b>	18.5	<b>3 468.03</b>	NES100-80-320-18.5/4SWH
	15	<b>2 987.50</b>	NES100-80-320-15/4SWH
	11	<b>2 783.97</b>	NES100-80-320-11/4SWH
<b>100-80-400</b>	30	<b>5 446.79</b>	NES100-80-400-30/4SWH
	22	<b>4 614.97</b>	NES100-80-400-22/4SWH
	18.5	<b>4 408.63</b>	NES100-80-400-18.5/4SWH

<b>150-125-400</b>	55	по запросу	NES150-125-400-55/4SWH
	45	<b>6 067.87</b>	NES150-125-400-45/4SWH
	37	<b>5 782.93</b>	NES150-125-400-37/4SWH
<b>SMM150-125-500</b>	45	<b>10 501.19</b>	NESSMM150-125-500-45/4SWH
<b>200-150-200</b>	18.5	<b>3 810.85</b>	NES200-150-200-18.5/4SWH
	15	<b>3 448.81</b>	NES200-150-200-15/4SWH
	11	<b>3 224.15</b>	NES200-150-200-11/4SWH
<b>200-150-260</b>	30	<b>4 977.31</b>	NES200-150-260-30/4SWH
	22	<b>4 292.77</b>	NES200-150-260-22/4SWH
	18.5	<b>4 155.39</b>	NES200-150-260-18.5/4SWH
<b>200-150-320</b>	55	по запросу	NES200-150-320-55/4SWH
	45	<b>5 885.92</b>	NES200-150-320-45/4SWH
	37	<b>5 600.97</b>	NES200-150-320-37/4SWH
<b>200-150-400</b>	30	по запросу	NES200-150-400-30/4SWH
	90	по запросу	NES200-150-400-90/4SWH
	75	по запросу	NES200-150-400-75/4SWH
	45	<b>7 907.34</b>	NES200-150-400-45/4SWH
<b>250-200-260</b>	55	по запросу	NES200-150-400-55/4SWH
	30	<b>5 691.86</b>	NES250-200-260-30/4SWH
	22	<b>5 007.51</b>	NES250-200-260-22/4SWH
	18.5	<b>4 870.13</b>	NES250-200-260-18.5/4SWH
<b>250-200-320</b>	15	<b>4 547.63</b>	NES250-200-260-15/4SWH
	75	по запросу	NES250-200-320-75/4SWH
	55	по запросу	NES250-200-320-55/4SWH
	45	<b>7 673.34</b>	NES250-200-320-45/4SWH
<b>250-200-400</b>	37	<b>7 362.29</b>	NES250-200-320-37/4SWH
	132	по запросу	NES250-200-400-132/4SWH
	110	по запросу	NES250-200-400-110/4SWH
<b>300-250-320</b>	90	по запросу	NES250-200-400-90/4SWH
	55	по запросу	NES250-200-400-55/4SWH
	75	по запросу	NES250-200-400-75/4SWH
	90	по запросу	NES250-200-400-90/4SWH
<b>300-250-400</b>	75	по запросу	NES300-250-320-90/4SWH
	55	по запросу	NES300-250-320-75/4SWH
	45	<b>11 965.82</b>	NES300-250-320-45/4SWH
	160	по запросу	NES300-250-400-160/4SWH
<b>300-250-400</b>	132	по запросу	NES300-250-400-132/4SWH
	110	по запросу	NES300-250-400-110/4SWH
	90	по запросу	NES300-250-400-90/4SWH
	75	по запросу	NES300-250-400-75/4SWH



## NESO АГРЕГАТЫ ЭЛЕКТРОНАСОСНЫЕ КОНСОЛЬНЫЕ (стандарт EN733)

**NES(0) 100 - 80 - 320(300) - 18,5/ 2 x x x**



Цены указаны для насосов NES следующего конструктива:  
Насосная часть - чугун, рабочее колесо - чугун, торцевое уплотнение, вал - нерж. сталь (CI-CI-SS-MS)  
Стоимость насоса вертикальной установки: до 45кВт +15%, свыше 45кВт +10% к прайсовой цене

обновление 15.02.2023

Модель агрегата	Мощность, кВт	Цена розница USD с НДС	Артикул
-----------------	---------------	------------------------	---------

2-х полюсные, 50Гц, 2900 об/мин

50-32-130	2.2	1 907.99	NES050-32-130-2.2/2SWH
	1.5	1 878.30	NES050-32-130-1.5/2SWH
	1.1	1 847.45	NES050-32-130-1.1/2SWH
	0.75	1 827.32	NES050-32-130-0.75/2SWH
50-32-160	5.5	2 467.21	NES050-32-160-5.5/2SWH
	4	2 329.52	NES050-32-160-4/2SWH
	3	2 251.31	NES050-32-160-3/2SWH
	2.2	2 164.95	NES050-32-160-2.2/2SWH
65-40-130	1.5	2 113.16	NES050-32-160-1.5/2SWH
	11	3 527.66	NES050-32-200-11/2SWH
	7.5	2 928.08	NES050-32-200-7.5/2SWH
50-32-200	5.5	2 395.03	NES050-32-200-5.5/2SWH
	4	2 205.32	NES050-32-200-4/2SWH
	18.5	3 774.76	NES050-32-260-18.5/2SWH
	15	3 634.31	NES050-32-260-15/2SWH
50-32-260	11	3 494.53	NES050-32-260-11/2SWH
	4	2 045.78	NES065-40-130-4/2SWH
	3	1 967.56	NES065-40-130-3/2SWH
65-40-160	2.2	1 881.21	NES065-40-130-2.2/2SWH
	1.5	1 804.37	NES065-40-130-1.5/2SWH
	7.5	2 616.13	NES065-40-160-7.5/2SWH
	5.5	2 548.68	NES065-40-160-5.5/2SWH
65-40-200	4	2 358.97	NES065-40-160-4/2SWH
	3	2 220.07	NES065-40-160-3/2SWH
	11	3 283.77	NES065-40-200-11/2SWH
	7.5	2 487.72	NES065-40-200-7.5/2SWH
65-40-260	5.5	2 420.26	NES065-40-200-5.5/2SWH
	22	4 138.35	NES065-40-260-22/2SWH
	18.5	3 748.15	NES065-40-260-18.5/2SWH
	15	3 607.71	NES065-40-260-15/2SWH
100-80-260	11	3 419.85	NES065-40-260-11/2SWH

Модель агрегата	Мощность, кВт	Цена розница USD с НДС	Артикул
-----------------	---------------	------------------------	---------

80-65-130	11	3 214.15	NES080-65-130-11/2SWH
	7.5	2 418.10	NES080-65-130-7.5/2SWH
	5.5	2 363.39	NES080-65-130-5.5/2SWH
80-65-160	18.5	3 817.55	NES080-65-160-18.5/2SWH
	15	3 677.11	NES080-65-160-15/2SWH
	11	3 537.32	NES080-65-160-11/2SWH
	7.5	3 445.47	NES080-65-160-7.5/2SWH
80-65-200H	5.5	3 311.07	NES080-65-160-5.5/2SWH
	30	4 495.63	NES080-65-200H-30/2SWH
	22	3 979.49	NES080-65-200H-22/2SWH
	18.5	3 675.03	NES080-65-200H-18.5/2SWH
80-65-260	15	3 534.59	NES080-65-200H-15/2SWH
	55	по запросу	NES080-65-260-55/2SWH
	45	5 964.59	NES080-65-260-45/2SWH
	37	5 221.68	NES080-65-260-37/2SWH
80-65-320H	30	4 987.79	NES080-65-260-30/2SWH
	90	по запросу	NES080-65-320H-90/2SWH
	75	по запросу	NES080-65-320H-75/2SWH
	55	по запросу	NES080-65-320H-55/2SWH
100-80-160	45	6 901.87	NES080-65-320H-45/2SWH
	30	4 726.26	NES0100-80-160-30/2SWH
	22	4 210.11	NES0100-80-160-22/2SWH
	18.5	3 905.66	NES0100-80-160-18.5/2SWH
100-80-200	15	3 765.21	NES0100-80-160-15/2SWH
	11	3 744.61	NES0100-80-160-11/2SWH
	45	6 380.62	NES0100-80-200-45/2SWH
	37	5 112.24	NES0100-80-200-37/2SWH
100-80-260	30	4 878.35	NES0100-80-200-30/2SWH
	22	4 370.21	NES0100-80-200-22/2SWH
	75	по запросу	NES0100-80-260-75/2SWH
	55	по запросу	NES0100-80-260-55/2SWH

65-40-320H	45	6 592.38	NES065-40-320H-45/2SWH
	37	5 538.18	NES065-40-320H-37/2SWH
	30	5 257.41	NES065-40-320H-30/2SWH
	22	4 594.96	NES065-40-320H-22/2SWH
65-50-130	7.5	2 358.77	NES065-50-130 -7.5/2SWH
	5.5	2 291.32	NES065-50-130 -5.5/2SWH
	4	2 101.60	NES065-50-130 -4/2SWH
65-50-160	3	2 047.04	NES065-50-130 -3/2SWH
	11	3 447.70	NES065-50-160 -11/2SWH
	7.5	2 651.65	NES065-50-160 -7.5/2SWH
65-50-200	5.5	2 584.20	NES065-50-160 -5.5/2SWH
	4	2 539.24	NES065-50-160 -4/2SWH
	18.5	3 609.76	NES065-50-200-18.5/2SWH
65-50-260H	15	3 469.32	NES065-50-200-15/2SWH
	11	3 329.53	NES065-50-200-11/2SWH
	7.5	3 195.24	NES065-50-200-7.5/2SWH
	37	4 850.79	NES065-50-260H-37/2SWH
65-50-320H	30	4 616.91	NES065-50-260H-30/2SWH
	22	4 100.76	NES065-50-260H-22/2SWH
	18.5	3 818.09	NES065-50-260H-18.5/2SWH
	75	по запросу	NES065-50-320H-75/2SWH
65-50-200	55	по запросу	NES065-50-320H-55/2SWH
	45	6 178.68	NES065-50-320H-45/2SWH
	37	5 529.02	NES065-50-320H-37/2SWH
	30	5 201.88	NES065-50-320H-30/2SWH

100-80-320H	45	6 619.93	NES0100-80-260-45/2SWH
	37	5 965.59	NES0100-80-260-37/2SWH
	132	по запросу	NES0100-80-320H-132/2SWH
	110		NES0100-80-320H-110/2SWH
90	NES0100-80-320H-90/2SWH		
75	NES0100-80-320H-75/2SWH		
125-100-160	30	4 867.00	NES0125-100-160-30/2SWH
	22	4 350.85	NES0125-100-160-22/2SWH
	18.5	3 895.29	NES0125-100-160-18.5/2SWH
125-100-200	15	3 781.58	NES0125-100-160-15/2SWH
	75	по запросу	NES0125-100-200-75/2SWH
	55	по запросу	NES0125-100-200-55/2SWH
	45	6 039.09	NES0125-100-200-45/2SWH
125-100-260H	37	5 296.17	NES0125-100-200-37/2SWH
	30	5 045.93	NES0125-100-200-30/2SWH
	132	по запросу	NES0125-100-260H-132/2SWH
	110		NES0125-100-260H-110/2SWH
	90		NES0125-100-260H-90/2SWH
75	NES0125-100-260H-75/2SWH		
55	NES0125-100-260H-55/2SWH		
150-125-200	90	по запросу	NES0150-125-200-90/2SWH
	75	по запросу	NES0150-125-200-75/2SWH
	55	по запросу	NES0150-125-200-55/2SWH
	45	7 048.28	NES0150-125-200-45/2SWH

Модель агрегата	Мощность, кВт	Цена розница USD с НДС	Артикул
-----------------	---------------	------------------------	---------

Модель агрегата	Мощность, кВт	Цена розница USD с НДС	Артикул
-----------------	---------------	------------------------	---------

4-х полюсные, 50Гц, 1450об/мин

50-32-130	0.55	1 829.44	NES050-32-130-0.55/4SWH
	0.37	1 829.44	NES050-32-130-0.37/4SWH
50-32-160	0.75	2 095.52	NES050-32-160-0.75/4SWH
	0.55	2 086.40	NES050-32-160-0.55/4SWH
50-32-200	1.1	2 008.78	NES050-32-200-1.1/4SWH
	0.75	1 971.32	NES050-32-200-0.75/4SWH
	0.55	1 927.83	NES050-32-200-0.55/4SWH
50-32-260	3	2 376.18	NES050-32-260-3/4SWH
	2.2	2 343.03	NES050-32-260-2.2/4SWH
	1.5	2 273.27	NES050-32-260-1.5/4SWH
65-40-130	0.55	1 802.65	NES065-40-130-0.55/4SWH
	0.37	1 802.65	NES065-40-130-0.37/4SWH
65-40-160	1.1	2 162.42	NES065-40-160-1.1/4SWH
	0.75	2 124.97	NES065-40-160-0.75/4SWH
	0.55	2 115.85	NES065-40-160-0.55/4SWH
65-40-200	1.5	2 062.51	NES065-40-200-1.5/4SWH
65-40-200	1.1	2 034.01	NES065-40-200-1.1/4SWH
	0.75	1 989.82	NES065-40-200-0.75/4SWH
65-40-260	3	2 349.57	NES065-40-260-3/4SWH
	2.2	2 316.43	NES065-40-260-2.2/4SWH
	1.5	2 260.13	NES065-40-260-1.5/4SWH
65-40-320	7.5	3 748.54	NES065-40-320-7.5/4SWH
	5.5	3 640.91	NES065-40-320-5.5/4SWH
	4	3 441.96	NES065-40-320-4/4SWH
	3	3 381.25	NES065-40-320-3/4SWH
65-50-130	1.1	1 905.06	NES065-50-130-1.1/4SWH
	0.75	1 867.60	NES065-50-130-0.75/4SWH
	0.55	1 858.48	NES065-50-130-0.55/4SWH
65-50-160	1.5	2 226.44	NES065-50-160-1.5/4SWH
	1.1	2 197.94	NES065-50-160-1.1/4SWH
	0.75	2 160.48	NES065-50-160-0.75/4SWH
	0.55	2 156.76	NES065-50-160-0.55/4SWH
65-50-200	2.2	2 178.03	NES065-50-200-2.2/4SWH
	1.5	2 121.70	NES065-50-200-1.5/4SWH
	1.1	2 090.34	NES065-50-200-1.1/4SWH
65-50-260	5.5	2 681.11	NES065-50-260-5.5/4SWH
	4	2 476.46	NES065-50-260-4/4SWH
	3	2 397.73	NES065-50-260-3/4SWH
65-50-320	11	4 160.65	NES065-50-320-11/4SWH
	7.5	3 811.42	NES065-50-320-7.5/4SWH
	5.5	3 731.68	NES065-50-320-5.5/4SWH
80-65-130	1.5	1 992.89	NES080-65-130-1.5/4SWH
	1.1	1 964.39	NES080-65-130-1.1/4SWH
	0.75	1 933.91	NES080-65-130-0.75/4SWH

125-100-160	4	3 105.10	NES0125-100-160-4/4SWH
	3	3 012.12	NES0125-100-160-3/4SWH
	2.2	2 970.42	NES0125-100-160-2.2/4SWH
125-100-200	11	4 034.27	NES0125-100-200-11/4SWH
	7.5	3 671.83	NES0125-100-200-7.5/4SWH
	5.5	3 592.08	NES0125-100-200-5.5/4SWH
	4	3 387.44	NES0125-100-200-4/4SWH
125-100-260	3	3 286.75	NES0125-100-200-3/4SWH
	15	4 379.35	NES0125-100-260-15/4SWH
	11	4 215.37	NES0125-100-260-11/4SWH
125-100-320	7.5	3 889.63	NES0125-100-260-7.5/4SWH
	22	5 092.59	NES0125-100-320-22/4SWH
	18.5	4 815.25	NES0125-100-320-18.5/4SWH
	15	4 529.05	NES0125-100-320-15/4SWH
125-100-400	11	4 365.07	NES0125-100-320-11/4SWH
	45	7 869.18	NES0125-100-400-45/4SWH
	37	7 201.44	NES0125-100-400-37/4SWH
150-125-200	30	6 578.94	NES0125-100-400-30/4SWH
	22	6 094.84	NES0125-100-400-22/4SWH
	11	4 178.87	NES0150-125-200-11/4SWH
150-125-260	7.5	3 829.65	NES0150-125-200-7.5/4SWH
	5.5	3 746.70	NES0150-125-200-5.5/4SWH
	22	5 046.01	NES0150-125-260-22/4SWH
	18.5	4 769.67	NES0150-125-260-18.5/4SWH
150-125-320	15	4 483.46	NES0150-125-260-15/4SWH
	11	4 319.48	NES0150-125-260-11/4SWH
	30	6 457.30	NES0150-125-320-30/4SWH
	22	5 913.17	NES0150-125-320-22/4SWH
	18.5	5 773.59	NES0150-125-320-18.5/4SWH
150-125-400	15	5 540.20	NES0150-125-320-15/4SWH
	75	по запросу	NES0150-125-400-75/4SWH
	55	по запросу	NES0150-125-400-55/4SWH
	45	7 821.03	NES0150-125-400-45/4SWH
200-150-200	37	7 482.72	NES0150-125-400-37/4SWH
	30	6 984.87	NES0150-125-400-30/4SWH
	18.5	5 079.00	NES0200-150-200-18.5/4SWH
	15	4 792.80	NES0200-150-200-15/4SWH
200-150-260	11	4 631.89	NES0200-150-200-11/4SWH
	30	6 361.08	NES0200-150-260-30/4SWH
	22	5 816.94	NES0200-150-260-22/4SWH
	18.5	5 677.36	NES0200-150-260-18.5/4SWH
	15	5 403.10	NES0200-150-260-15/4SWH
200-150-320	55	по запросу	NES0200-150-320-55/4SWH
	45	7 824.31	NES0200-150-320-45/4SWH

<b>80-65-160</b>	2.2	<b>2 385.82</b>	NES080-65-160-2.2/4SWH
	1.5	<b>2 316.06</b>	NES080-65-160-1.5/4SWH
	1.1	<b>2 284.66</b>	NES080-65-160-1.1/4SWH
<b>80-65-200</b>	4	<b>2 355.18</b>	NES080-65-200-4/4SWH
	3	<b>2 276.45</b>	NES080-65-200-3/4SWH
	2.2	<b>2 243.31</b>	NES080-65-200-2.2/4SWH
<b>80-65-260</b>	7.5	<b>3 597.33</b>	NES080-65-260-7.5/4SWH
	5.5	<b>3 517.59</b>	NES080-65-260-5.5/4SWH
	4	<b>3 312.94</b>	NES080-65-260-4/4SWH
<b>80-65-320</b>	15	<b>4 375.58</b>	NES080-65-320-15/4SWH
	11	<b>4 211.60</b>	NES080-65-320-11/4SWH
	7.5	<b>3 862.37</b>	NES080-65-320-7.5/4SWH
	5.5	<b>3 779.98</b>	NES080-65-320-5.5/4SWH
<b>100-80-160</b>	4	<b>2 585.81</b>	NES0100-80-160-4/4SWH
	3	<b>2 507.08</b>	NES0100-80-160-3/4SWH
	2.2	<b>2 473.93</b>	NES0100-80-160-2.2/4SWH
	1.5	<b>2 405.21</b>	NES0100-80-160-1.5/4SWH
<b>100-80-200</b>	7.5	<b>3 515.62</b>	NES0100-80-200-7.5/4SWH
	5.5	<b>3 408.15</b>	NES0100-80-200-5.5/4SWH
	4	<b>3 203.50</b>	NES0100-80-200-4/4SWH
	3	<b>3 128.36</b>	NES0100-80-200-3/4SWH
<b>100-80-260</b>	11	<b>4 076.44</b>	NES0100-80-260-11/4SWH
	7.5	<b>3 727.21</b>	NES0100-80-260-7.5/4SWH
	5.5	<b>3 647.47</b>	NES0100-80-260-5.5/4SWH
	4	<b>3 448.62</b>	NES0100-80-260-4/4SWH
<b>100-80-320</b>	18.5	<b>4 773.44</b>	NES0100-80-320-18.5/4SWH
	15	<b>4 487.23</b>	NES0100-80-320-15/4SWH
	11	<b>4 323.25</b>	NES0100-80-320-11/4SWH
	7.5	<b>4 013.41</b>	NES0100-80-320-7.5/4SWH
<b>100-80-400</b>	30	<b>6 407.25</b>	NES0100-80-400-30/4SWH
	22	<b>5 832.46</b>	NES0100-80-400-22/4SWH
	18.5	<b>5 686.89</b>	NES0100-80-400-18.5/4SWH
	15	<b>5 413.75</b>	NES0100-80-400-15/4SWH

<b>200-150-320</b>	37	<b>7 486.00</b>	NES0200-150-320-37/4SWH
	30	<b>6 977.49</b>	NES0200-150-320-30/4SWH
	22	<b>6 500.79</b>	NES0200-150-320-22/4SWH
<b>200-150-400</b>	90	<b>по запросу</b>	NES0200-150-400-90/4SWH
	75		NES0200-150-400-75/4SWH
	55		NES0200-150-400-55/4SWH
	45	<b>8 252.69</b>	NES0200-150-400-45/4SWH
	37	<b>7 880.04</b>	NES0200-150-400-37/4SWH
<b>250-200-260</b>	30	<b>7 700.89</b>	NES0250-200-260-30/4SWH
	22	<b>7 156.76</b>	NES0250-200-260-22/4SWH
	18.5	<b>7 017.17</b>	NES0250-200-260-18.5/4SWH
	15	<b>6 743.42</b>	NES0250-200-260-15/4SWH
<b>250-200-320</b>	75	<b>по запросу</b>	NES0250-200-320-75/4SWH
	55		NES0250-200-320-55/4SWH
	45	<b>10 502.73</b>	NES0250-200-320-45/4SWH
	37	<b>10 148.07</b>	NES0250-200-320-37/4SWH
	30	<b>9 650.86</b>	NES0250-200-320-30/4SWH
<b>250-200-400</b>	132	<b>по запросу</b>	NES0250-200-400-132/4SWH
	110		NES0250-200-400-110/4SWH
	90		NES0250-200-400-90/4SWH
	75		NES0250-200-400-75/4SWH
	55		NES0250-200-400-55/4SWH
<b>300-250-320</b>	90		NES0300-250-320-90/4SWH
	75		NES0300-250-320-75/4SWH
	55		NES0300-250-320-55/4SWH
	45	<b>11 652.06</b>	NES0300-250-320-45/4SWH
<b>300-250-400</b>	37	<b>11 298.05</b>	NES0300-250-320-37/4SWH
	185	<b>по запросу</b>	NES0300-250-400-185/4SWH
	160		NES0300-250-400-160/4SWH
	132		NES0300-250-400-132/4SWH
	110		NES0300-250-400-110/4SWH
90	NES0300-250-400-90/4SWH		
75		NES0300-250-400-75/4SWH	

Skid\_id указан для стандартного исполнения: Материал корпуса - GG25; Материал колеса - GG25; Материал вала - SS420; Уплотнение - сальниковое; смазка - консистентная; Энергия - 3\*380; частота - 50 Гц; Цвет - Чёрный 9005; Двигатели+рама+муфта; Обычная нагрузка

Насосные агрегаты комплектуются двигателями с классом защиты IP55 в стандартном исполнении (по цене агрегата с двигателем IP54)!!!

## СММ АГРЕГАТЫ ЭЛЕКТРОНАСОСНЫЕ КОНСОЛЬНО-МОНОБЛОЧНЫЕ по стандарту ISO2858

Насосные агрегаты комплектуются двигателями с классом защиты IP55 в стандартном исполнении (по цене агрегата с двигателем IP54)!!!

обновление 15.02.2023

Модель агрегата	Мощность, кВт	Цена розница USD с НДС	Артикул	Модель агрегата	Мощность, кВт	Цена розница USD с НДС	Артикул
<b>2-х полюсные, 50Гц, 2900 об/мин</b>							
50-32-160	5.5	<b>1 217.40</b>	SMM50-32-160 -5,5/2	80-65-160	18.5	<b>2 771.00</b>	SMM80-65-160-18,5/2
	4	<b>1 217.40</b>	SMM50-32-160 -4/2		15	<b>2 603.09</b>	SMM80-65-160-15/2
	3	<b>1 137.76</b>	SMM50-32-160 -3/2		11	<b>2 502.34</b>	SMM80-65-160-11/2
	2.2	<b>1 009.25</b>	SMM50-32-160 -2,2/2		7.5	<b>2 059.99</b>	SMM80-65-160-7,5/2
50-32-200	1.5	<b>976.19</b>	SMM50-32-160 -1,5/2	100-65-200	37	<b>4 536.82</b>	SMM100-65-200-37/2
	11	<b>2 195.27</b>	SMM50-32-200 -11/2		30	<b>3 861.31</b>	SMM100-65-200-30/2
	7.5	<b>1 653.03</b>	SMM50-32-200 -7,5/2		22	<b>3 138.49</b>	SMM100-65-200-22/2
	5.5	<b>1 597.06</b>	SMM50-32-200 -5,5/2		18.5	<b>2 674.00</b>	SMM100-65-200-18,5/2
65-40-200	4	<b>1 477.68</b>	SMM50-32-200 -4/2	100-65-250	15	<b>2 506.09</b>	SMM100-65-200-15/2
	15	<b>2 521.20</b>	SMM65-40-200 -15/2		55.75	по запросу	SMM100-65-250-55,75/2
	11	<b>2 411.89</b>	SMM65-40-200 -11/2		45	<b>4 865.07</b>	SMM100-65-250-45/2
	7.5	<b>1 679.61</b>	SMM65-40-200 -7,5/2		37	<b>4 166.79</b>	SMM100-65-250-37/2
65-40-250	5.5	<b>1 623.64</b>	SMM65-40-200 -5,5/2	100-65-315	30	<b>3 903.72</b>	SMM100-65-250-30/2
	30	<b>4 007.30</b>	SMM65-40-250-30/2		90,110,132	по запросу	SMM100-65-315-90/2
	22	<b>3 457.97</b>	SMM65-40-250-22/2		75	по запросу	SMM100-65-315-75/2
	18.5	<b>2 876.95</b>	SMM65-40-250-18,5/2		55	по запросу	SMM100-65-315-55/2
65-40-315	15	<b>2 553.51</b>	SMM65-40-250-15/2	100-80-160	45	<b>7 451.32</b>	SMM100-65-315-45/2
	45	<b>5 662.87</b>	SMM65-40-315-45/2		30	<b>3 772.91</b>	SMM100-80-160-30/2
	37	<b>4 958.18</b>	SMM65-40-315-37/2		22	<b>3 227.50</b>	SMM100-80-160-22/2
	30	<b>4 641.43</b>	SMM65-40-315-30/2		18.5	<b>2 606.55</b>	SMM100-80-160-18,5/2
65-50-160	22	<b>3 867.70</b>	SMM65-40-315-22/2	125-100-200	11	<b>2 338.71</b>	SMM100-80-160-11/2
	11	<b>2 267.60</b>	SMM65-50-160 -11/2		15	<b>2 438.64</b>	SMM100-80-160-15/2
	7.5	<b>1 600.89</b>	SMM65-50-160 -7,5/2		75	по запросу	SMM125-100-200-75/2
	5.5	<b>1 544.92</b>	SMM65-50-160 -5,5/2		55	по запросу	SMM125-100-200-55/2
80-50-200	22	<b>3 490.66</b>	SMM80-50-200-22/2	125-100-250	45	<b>5 081.29</b>	SMM125-100-200-45/2
	18.5	<b>2 603.32</b>	SMM80-50-200-18,5/2		37	<b>4 474.08</b>	SMM125-100-200-37/2
	15	<b>2 435.41</b>	SMM80-50-200-15/2		30	<b>4 189.16</b>	SMM125-100-200-30/2
	11	<b>2 446.25</b>	SMM80-50-200-11/2		110	по запросу	SMM125-100-250-110/2
	7.5	<b>2 334.66</b>	SMM80-50-200-7,5/2		132	по запросу	SMM125-100-250-132/2
80-50-250	45	<b>6 015.29</b>	SMM80-50-250-45/2	125-100-315	90	по запросу	SMM125-100-250-90/2
	37	<b>4 763.76</b>	SMM80-50-250-37/2		75	по запросу	SMM125-100-250-75/2
	30	<b>4 447.00</b>	SMM80-50-250-30/2		90	по запросу	SMM125-100-315-90/2
	22	<b>3 226.94</b>	SMM80-50-250-22/2		110	по запросу	SMM125-100-315-110/2
	18.5	<b>2 765.61</b>	SMM80-50-250-18,5/2		132	по запросу	SMM125-100-315-132/2
80-50-315	75	по запросу	SMM80-50-315-75/2	150-125-200	160	по запросу	SMM125-100-315-160/2
	55	по запросу	SMM80-50-315-55/2		90	по запросу	SMM150-125-200-90/2
	45	<b>5 635.85</b>	SMM80-50-315-45/2		75	по запросу	SMM150-125-200-75/2
	37	<b>4 963.96</b>	SMM80-50-315-37/2		55	по запросу	SMM150-125-200-55/2
	30	<b>4 679.43</b>	SMM80-50-315-30/2		160	по запросу	SMM150-125-250-160/2
100-80-315	90	по запросу	SMM100-80-315-90/2	150-125-250	132	по запросу	SMM150-125-250-132/2
	75	по запросу	SMM100-80-315-75/2		110	по запросу	SMM150-125-250-110/2
					90	по запросу	SMM150-125-250-90/2
				150-125-315	90	по запросу	SMM150-125-315-90/2
					110	по запросу	SMM150-125-315-110/2
					132	по запросу	SMM150-125-315-132/2
					160	по запросу	SMM150-125-315-160/2
				200	по запросу	SMM150-125-315-200/2	

Модель агрегата	Мощность, кВт	Цена розница USD с НДС	Артикул	Модель агрегата	Мощность, кВт	Цена розница USD с НДС	Артикул
<b>4-х полюсные, 50Гц, 1450об/мин</b>							
50-32-160	0.55	<b>888.22</b>	SMM50-32-160-0,55/4	125-100-315	22	<b>3 889.38</b>	SMM125-100-315-22/4
50-32-200	1.1	<b>1 199.36</b>	SMM50-32-200-1,1/4		30	<b>4 811.76</b>	SMM125-100-315-30/4
	0.75	<b>1 039.77</b>	SMM50-32-200-0,75/4		18.5	<b>3 721.21</b>	SMM125-100-315-18,5/4
	0.55	<b>1 009.03</b>	SMM50-32-200-0,55/4		15	<b>3 341.15</b>	SMM125-100-315-15/4
65-40-200	1.5	<b>1 170.86</b>	SMM65-40-200-1,5/4	125-100-400	45	<b>6 776.47</b>	SMM125-100-400-45/4
	0.75	<b>1 109.36</b>	SMM65-40-200-0,75/4		37	<b>6 399.00</b>	SMM125-100-400-37/4
	1.1	<b>1 142.87</b>	SMM65-40-200-1,1/4		30	<b>5 976.03</b>	SMM125-100-400-30/4

65-40-250	3	<b>1 506.96</b>	SMM65-40-250-3/4	150-125-250	22	<b>5 053.65</b>	SMM125-100-400-22/4
	1.5	<b>1 379.72</b>	SMM65-40-250-1,5/4		22	<b>3 857.10</b>	SMM150-125-250-22/4
	2.2	<b>1 456.59</b>	SMM65-40-250-2,2/4		30	<b>4 779.48</b>	SMM150-125-250-30/4
65-40-315	7.5	<b>2 377.10</b>	SMM65-40-315-7,5/4	18.5	<b>3 675.73</b>	SMM150-125-250-18,5/4	
	5.5	<b>2 235.75</b>	SMM65-40-315-5,5/4	15	<b>3 296.34</b>	SMM150-125-250-15/4	
	4	<b>2 006.18</b>	SMM65-40-315-4/4	30	<b>6 124.56</b>	SMM150-125-315-30/4	
65-50-160	1.5	<b>1 059.00</b>	SMM65-50-160-1,5/4	22	<b>5 193.24</b>	SMM150-125-315-22/4	
	1.1	<b>1 031.02</b>	SMM65-50-160-1,1/4	18.5	<b>5 042.11</b>	SMM150-125-315-18,5/4	
	0.75	<b>970.68</b>	SMM65-50-160-0,75/4	15	<b>4 442.81</b>	SMM150-125-315-15/4	
80-50-200	2.2	<b>1 309.09</b>	SMM80-50-200-2,2/4	75	<b>по запросу</b>	SMM150-125-400-75/4	
	1.1	<b>1 234.46</b>	SMM80-50-200-1,1/4	55	<b>по запросу</b>	SMM150-125-400-55/4	
	1.5	<b>1 262.13</b>	SMM80-50-200-1,5/4	45	<b>6 674.66</b>	SMM150-125-400-45/4	
80-50-250	5.5	<b>1 957.65</b>	SMM80-50-250-5,5/4	37	<b>6 361.22</b>	SMM150-125-400-37/4	
	4	<b>1 628.87</b>	SMM80-50-250-4/4	45	<b>11 551.31</b>	SMM150-125-500-45/4	
	3	<b>1 544.56</b>	SMM80-50-250-3/4	55	<b>по запросу</b>	SMM150-125-500-55/4	
80-50-315	11	<b>2 931.04</b>	SMM80-50-315-11/4	75	<b>по запросу</b>	SMM150-125-500-75/4	
	7.5	<b>2 412.56</b>	SMM80-50-315-7,5/4	90	<b>по запросу</b>	SMM150-125-500-90/4	
	5.5	<b>2 289.42</b>	SMM80-50-315-5,5/4	110	<b>по запросу</b>	SMM150-125-500-110/4	
80-65-160	2.2	<b>1 274.72</b>	SMM80-65-160-2,2/4	132	<b>по запросу</b>	SMM150-125-500-132/4	
	1.5	<b>1 560.25</b>	SMM80-65-160-1,5/4	75	<b>по запросу</b>	SMM200-150-315-75/4	
	1.1	<b>1 514.25</b>	SMM80-65-160-1,1/4	55	<b>по запросу</b>	SMM200-150-315-55/4	
100-65-200	7.5	<b>2 083.05</b>	SMM100-65-200-7,5/4	45	<b>6 474.51</b>	SMM200-150-315-45/4	
	5.5	<b>1 975.47</b>	SMM100-65-200-5,5/4	37	<b>6 161.07</b>	SMM200-150-315-37/4	
	3	<b>1 651.42</b>	SMM100-65-200-3/4	30	<b>5 475.04</b>	SMM200-150-315-30/4	
	4	<b>1 712.92</b>	SMM100-65-200-4/4	110	<b>по запросу</b>	SMM200-150-400-110/4	
100-65-260	11	<b>2 834.30</b>	SMM100-65-260-11/4	90	<b>по запросу</b>	SMM200-150-400-90/4	
	7.5	<b>2 379.88</b>	SMM100-65-260-7,5/4	75	<b>по запросу</b>	SMM200-150-400-75/4	
	5.5	<b>2 256.75</b>	SMM100-65-260-5,5/4	55	<b>по запросу</b>	SMM200-150-400-55/4	
100-65-315	18.5	<b>3 814.83</b>	SMM100-65-315-18,5/4	45	<b>8 698.07</b>	SMM200-150-400-45/4	
	15	<b>3 286.25</b>	SMM100-65-315-15/4	132	<b>по запросу</b>	SMM200-150-500-132/4	
	11	<b>3 062.36</b>	SMM100-65-315-11/4	160	<b>по запросу</b>	SMM200-150-500-160/4	
100-80-400	30	<b>5 991.47</b>	SMM100-80-400-30/4	132	<b>по запросу</b>	SMM200-150-500-132/4	
	22	<b>5 076.47</b>	SMM100-80-400-22/4	110	<b>по запросу</b>	SMM200-150-500-110/4	
	18.5	<b>4 849.49</b>	SMM100-80-400-18,5/4	90	<b>по запросу</b>	SMM200-150-500-90/4	
125-100-200	11	<b>2 704.78</b>	SMM125-100-200-11/4	75	<b>по запросу</b>	SMM200-150-500-75/4	
	7.5	<b>2 287.18</b>	SMM125-100-200-7,5/4	30	<b>6 261.05</b>	SMM250-200-250-30/4	
	5.5	<b>2 164.05</b>	SMM125-100-200-5,5/4	22	<b>5 508.26</b>	SMM250-200-250-22/4	
125-100-250	4	<b>1 901.70</b>	SMM125-100-200-4/4	18.5	<b>5 357.14</b>	SMM250-200-250-18,5/4	
	15	<b>3 182.43</b>	SMM125-100-250-15/4	15	<b>5 002.39</b>	SMM250-200-250-15/4	
	11	<b>2 958.55</b>	SMM125-100-250-11/4	75	<b>по запросу</b>	SMM250-200-315-75/4	
				55	<b>по запросу</b>	SMM250-200-315-55/4	
				45	<b>8 440.68</b>	SMM250-200-315-45/4	
				37	<b>8 098.52</b>	SMM250-200-315-37/4	
				160	<b>по запросу</b>	SMM250-200-400-160/4	
				132	<b>по запросу</b>	SMM250-200-400-132/4	
				110	<b>по запросу</b>	SMM250-200-400-110/4	
				90	<b>по запросу</b>	SMM250-200-400-90/4	
				55	<b>по запросу</b>	SMM250-200-400-55/4	
				75	<b>по запросу</b>	SMM250-200-400-75/4	
				132	<b>по запросу</b>	SMM250-200-500-132/4	
				160	<b>по запросу</b>	SMM250-200-500-160/4	
				200	<b>по запросу</b>	SMM250-200-500-200/4	
				110	<b>по запросу</b>	SMM300-250-315-110/4	
				90	<b>по запросу</b>	SMM300-250-315-90/4	
				75	<b>по запросу</b>	SMM300-250-315-75/4	
				55	<b>по запросу</b>	SMM300-250-315-55/4	
				45	<b>13 162.41</b>	SMM300-250-315-45/4	
				250	<b>по запросу</b>	SMM300-250-400-250/4	
				220	<b>по запросу</b>	SMM300-250-400-220/4	
				200	<b>по запросу</b>	SMM300-250-400-200/4	
				160	<b>по запросу</b>	SMM300-250-400-160/4	
				132	<b>по запросу</b>	SMM300-250-400-132/4	
				110	<b>по запросу</b>	SMM300-250-400-110/4	
				90	<b>по запросу</b>	SMM300-250-400-90/4	
				75	<b>по запросу</b>	SMM300-250-400-75/4	
				90	<b>по запросу</b>	SMM350-300-400-90/4	
				110	<b>по запросу</b>	SMM350-300-400-110/4	
				132	<b>по запросу</b>	SMM350-300-400-132/4	
				160	<b>по запросу</b>	SMM350-300-400-160/4	
				200	<b>по запросу</b>	SMM350-300-400-200/4	
				220	<b>по запросу</b>	SMM350-300-400-220/4	
				250	<b>по запросу</b>	SMM350-300-400-250/4	
				90	<b>по запросу</b>	SMM350-300-500-90/4	
				110	<b>по запросу</b>	SMM350-300-500-110/4	
				132	<b>по запросу</b>	SMM350-300-500-132/4	
				160	<b>по запросу</b>	SMM350-300-500-160/4	
				200	<b>по запросу</b>	SMM350-300-500-200/4	
				220	<b>по запросу</b>	SMM350-300-500-220/4	
				250	<b>по запросу</b>	SMM350-300-500-250/4	
				315	<b>по запросу</b>	SMM350-300-500-315/4	



## NIS центробежные консольно-моноблочные насосы по стандарту DIN 24256

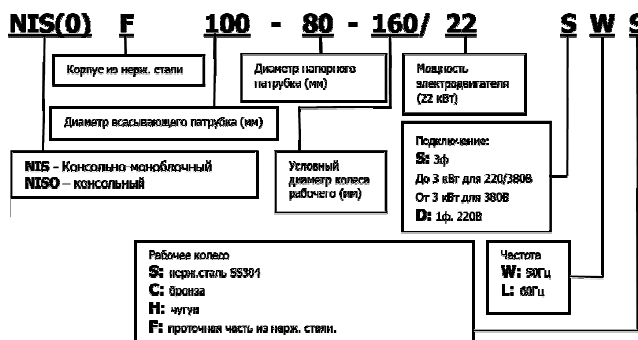

1. Цены в прайсе даны для насосов с двигателем 50Гц/ 380В.

обновление 15.02.2023

2. Материал: корпус насоса выполнен из чугуна с шаровидным графитом, а остальные детали (рабочее колесо, крышка насоса и т. д.) выполнены из серого чугуна.

Модель/Артикул	Кол-во полюсов	Мощность (кВт)	Цена розница (USD) с НДС
NIS50-32-160/3SWH	2	3	1 207.66
NIS50-32-160/4SWH	2	4	1 367.69
NIS50-32-160/5.5SWH	2	5.5	1 699.14
NIS50-32-200/7.5SWH	2	7.5	1 819.07
NIS50-32-200/11SWH	2	11	2 388.71
NIS65-40-200/7.5SWH	2	7.5	1 840.23
NIS65-40-200/11SWH	2	11	2 423.01
NIS65-40-200/15SWH	2	15	2 583.69
NIS65-40-250/18.5SWH	2	18.5	2 880.07
NIS65-40-250/22SWH	2	22	3 396.01
NIS65-40-250/30SWH	2	30	4 481.84
NIS65-40-315/22SWH	2	22	3 629.22
NIS65-40-315/30SWH	2	30	4 650.42
NIS65-40-315/37SWH	2	37	5 006.11
NIS65-40-315/45SWH	2	45	6 241.30
NIS65-50-160/4SWH	2	4	1 392.85
NIS65-50-160/5.5SWH	2	5.5	1 724.24
NIS65-50-160/7.5SWH	2	7.5	1 763.77
NIS80-50-200/11SWH	2	11	2 441.37
NIS80-50-200/15SWH	2	15	2 602.02
NIS80-50-200/18.5SWH	2	18.5	2 738.06
NIS80-50-200/22SWH	2	22	3 304.72
NIS80-50-250/30SWH	2	30	4 514.10
NIS80-50-250/37SWH	2	37	4 869.82
NIS80-50-315/37SWH	2	37	5 084.82
NIS80-50-315/45SWH	2	45	6 256.03
NIS80-50-315/55SWH	2	55	по запросу
NIS80-50-315/75SWH	2	75	
NIS80-65-160/5.5SWH	2	5.5	1 772.87
NIS80-65-160/7.5SWH	2	7.5	1 812.40
NIS80-65-160/11SWH	2	11	2 395.45
NIS80-65-160/15SWH	2	15	2 556.13
NIS100-65-200/18.5SWH	2	18.5	2 903.70
NIS100-65-200/22SWH	2	22	3 473.34



NIS100-65-200/30SWH	2	30	<b>4 502.91</b>
NIS100-65-200/37SWH	2	37	<b>4 858.60</b>
NIS100-65-250/45SWH	2	45	<b>6 237.92</b>
NIS100-65-250/55SWH	2	55	<b>по запросу</b>
NIS100-65-250/75SWH	2	75	
NIS100-65-315/90SWH	2	90	
NIS100-65-315/110SWH	2	110	
NIS100-65-200G/18.5SWH	2	18.5	<b>2 903.70</b>
NIS100-65-200G/22SWH	2	22	<b>3 473.34</b>
NIS100-65-200G/30SWH	2	30	<b>4 502.88</b>
NIS100-65-200G/37SWH	2	37	<b>4 858.63</b>
NIS100-65-250G/45SWH	2	45	<b>6 237.92</b>
NIS100-65-250G/55SWH	2	55	<b>по запросу</b>
NIS100-65-315G/75SWH	2	75	
NIS100-65-315G/90SWH	2	90	
NIS100-80-160G/11SWH	2	11	<b>2 595.41</b>
NIS100-80-160G/15SWH	2	15	<b>2 756.86</b>
NIS100-80-160G/18.5SWH	2	18.5	<b>2 888.47</b>
NIS100-80-160/11SWH	2	11	<b>2 595.41</b>
NIS100-80-160/15SWH	2	15	<b>2 756.86</b>
NIS100-80-160/18.5SWH	2	18.5	<b>2 888.50</b>
NIS100-80-160/22SWH	2	22	<b>3 449.50</b>
NIS125-100-200/30SWH	2	30	<b>4 734.18</b>
NIS125-100-200/37SWH	2	37	<b>5 089.90</b>
NIS125-100-200/45SWH	2	45	<b>6 228.84</b>
NIS125-100-200/55SWH	2	55	<b>по запросу</b>
NIS125-100-200/75SWH	2	75	
NIS125-100-250/75SWH	2	75	
NIS125-100-250/90SWH	2	90	
NIS125-100-250/110SWH	2	110	
NIS125-100-315/90SWH	2	90	
NIS125-100-315/110SWH	2	110	
NIS125-100-315/132SWH	2	132	
NIS125-100-315/160SWH	2	160	
NIS125-100-200G/30SWH	2	30	
NIS125-100-200G/37SWH	2	37	<b>5 089.90</b>
NIS125-100-200G/45SWH	2	45	<b>6 228.84</b>
NIS125-100-200G/55SWH	2	55	<b>по запросу</b>
NIS125-100-200G/75SWH	2	75	
NIS125-100-250G/75SWH	2	75	
NIS125-100-250G/90SWH	2	90	
NIS125-100-315G/110SWH	2	110	
NIS125-100-315G/132SWH	2	132	
NIS125-100-315G/160SWH	2	160	
NIS125-80-400/15SWH	2	15	<b>3 748.87</b>
NIS125-80-400/18.5SWH	2	18.5	<b>4 253.15</b>
NIS125-80-400/22SWH	2	22	<b>4 503.40</b>
NIS125-80-400/30SWH	2	30	<b>5 571.85</b>
NIS125-80-400/37SWH	2	37	<b>6 094.49</b>
NIS125-100-400/30SWH	2	30	<b>5 619.43</b>
NIS125-100-400/37SWH	2	37	<b>6 192.18</b>
NIS125-100-400/45SWH	2	45	<b>7 272.01</b>
NIS150-125-250/22SWH	4	22	<b>4 232.14</b>
NIS150-125-250/18.5SWH	4	18.5	<b>4 026.80</b>
NIS150-125-250/15SWH	4	15	<b>3 509.05</b>
NIS150-125-250/11SWH	4	11	<b>3 323.49</b>
NIS150-125-315/37SWH	4	37	<b>6 219.86</b>
NIS150-125-315/30SWH	4	30	<b>5 647.33</b>
NIS150-125-400/75SWH	4	75	<b>по запросу</b>
NIS150-125-400/55SWH	4	55	
NIS150-125-200G/5.5SWH	4	5.5	<b>2 688.24</b>
NIS150-125-200G/7.5SWH	4	7.5	<b>2 767.10</b>
NIS150-125-200G/11SWH	4	11	<b>3 321.89</b>
NIS150-125-250G/11SWH	4	11	<b>3 323.49</b>
NIS150-125-250G/15SWH	4	15	<b>3 509.08</b>
NIS150-125-250G/18.5SWH	4	18.5	<b>4 026.83</b>



NIS150-125-315G/30SWH	4	30	<b>5 647.33</b>
NIS150-125-315G/37SWH	4	37	<b>6 219.86</b>
NIS150-125-400G/45SWH	4	45	<b>7 473.60</b>
NIS150-125-400G/55SWH	4	55	<b>по запросу</b>
NIS150-125-400G/75SWH	4	75	
NIS150-125-400/45SWH	4	45	<b>7 473.63</b>
NIS150-125-250G/22SWH	4	22	<b>4 232.14</b>
NIS200-150-315/75SWH	4	75	<b>по запросу</b>
NIS200-150-315/55SWH	4	55	
NIS200-150-315/45SWH	4	45	<b>7 660.58</b>
NIS200-150-315/37SWH	4	37	<b>6 590.37</b>
NIS200-150-400/110SWH	4	110	<b>по запросу</b>
NIS200-150-400/90SWH	4	90	
NIS200-150-400/75SWH	4	75	
NIS200-150-250G/15SWH	4	15	<b>4 603.67</b>
NIS200-150-250G/18.5SWH	4	18.5	<b>5 396.71</b>
NIS200-150-250G/22SWH	4	22	<b>5 657.42</b>
NIS200-150-250G/30SWH	4	30	<b>7 035.88</b>
NIS200-150-315G/37SWH	4	37	<b>6 590.34</b>
NIS200-150-315G/45SWH	4	45	<b>7 660.58</b>
NIS200-150-315G/55SWH	4	55	<b>по запросу</b>
NIS200-150-400G/75SWH	4	75	
NIS200-150-400G/90SWH	4	90	
NIS200-150-400G/110SWH	4	110	
NIS250-200-250/22SWH	4	22	<b>6 164.22</b>
NIS250-200-250/30SWH	4	30	<b>7 297.23</b>
NIS250-200-250/37SWH	4	37	<b>7 536.80</b>
NIS250-200-250/45SWH	4	45	<b>8 803.77</b>
NIS250-200-315/37SWH	4	37	<b>6 918.50</b>
NIS250-200-315/45SWH	4	45	<b>7 988.70</b>
NIS250-200-315/55SWH	4	55	<b>по запросу</b>
NIS250-200-315/75SWH	4	75	
NIS250-200-400/90SWH	4	90	
NIS250-200-400/110SWH	4	110	
NIS250-200-400/132SWH	4	132	
NIS250-200-400/160SWH	4	160	
NIS50-32-160/0.55SWH	4	0.55	<b>925.58</b>
NIS50-32-160/0.75SWH	4	0.75	<b>935.66</b>
NIS50-32-200/1.1SWH	4	1.1	<b>1 101.88</b>
NIS50-32-200/1.5SWH	4	1.5	<b>1 150.02</b>
NIS65-40-200/1.1SWH	4	1.1	<b>1 105.73</b>
NIS65-40-200/1.5SWH	4	1.5	<b>1 153.40</b>
NIS65-40-200/2.2SWH	4	2.2	<b>1 297.66</b>
NIS65-40-250/3SWH	4	3	<b>1 471.96</b>
NIS65-40-315/4SWH	4	4	<b>1 844.88</b>
NIS65-40-315/5.5SWH	4	5.5	<b>2 294.56</b>
NIS65-50-160/0.55SWH	4	0.55	<b>951.11</b>
NIS65-50-160/0.75SWH	4	0.75	<b>960.42</b>
NIS65-50-160/1.1SWH	4	1.1	<b>1 051.78</b>
NIS80-50-200/1.5SWH	4	1.5	<b>1 181.45</b>
NIS80-50-200/2.2SWH	4	2.2	<b>1 326.57</b>
NIS80-50-200/3SWH	4	3	<b>1 376.40</b>
NIS80-50-250/4SWH	4	4	<b>1 662.70</b>
NIS80-50-250/5.5SWH	4	5.5	<b>2 121.79</b>
NIS80-50-315/5.5SWH	4	5.5	<b>2 355.09</b>
NIS80-50-315/7.5SWH	4	7.5	<b>2 428.85</b>
NIS80-65-160/0.75SWH	4	0.75	<b>992.04</b>
NIS80-65-160/1.1SWH	4	1.1	<b>1 086.90</b>
NIS80-65-160/1.5SWH	4	1.5	<b>1 134.55</b>
NIS100-65-200/3SWH	4	3	<b>1 529.88</b>
NIS100-65-200/4SWH	4	4	<b>1 672.91</b>
NIS100-65-200/5.5SWH	4	5.5	<b>2 133.17</b>
NIS100-65-250/5.5SWH	4	5.5	<b>2 289.61</b>
NIS100-65-250/7.5SWH	4	7.5	<b>2 365.37</b>
NIS100-65-315/11SWH	4	11	<b>3 138.07</b>
NIS100-65-315/15SWH	4	15	<b>3 311.09</b>

NIS100-80-160/1.5SWH	4	1.5	<b>1 275.20</b>
NIS100-80-160/2.2SWH	4	2.2	<b>1 408.26</b>
NIS100-80-160/3SWH	4	3	<b>1 458.09</b>
NIS100-65-200G/3SWH	4	3	<b>1 529.88</b>
NIS100-65-200G/4SWH	4	4	<b>1 672.91</b>
NIS100-65-250G/5.5SWH	4	5.5	<b>2 289.61</b>
NIS100-65-250G/7.5SWH	4	7.5	<b>2 365.37</b>
NIS100-65-315G/11SWH	4	11	<b>3 138.07</b>
NIS100-65-315G/15SWH	4	15	<b>3 311.09</b>
NIS100-80-160G/1.5SWH	4	1.5	<b>1 275.20</b>
NIS100-80-160G/2.2SWH	4	2.2	<b>1 408.26</b>
NIS125-100-200/4SWH	4	4	<b>1 807.17</b>
NIS125-100-200/5.5SWH	4	5.5	<b>2 278.44</b>
NIS125-100-200/7.5SWH	4	7.5	<b>2 351.03</b>
NIS125-100-200/11SWH	4	11	<b>2 828.09</b>
NIS125-100-250/15SWH	4	15	<b>3 371.74</b>
NIS125-100-315/11SWH	4	11	<b>3 352.15</b>
NIS125-100-315/18.5SWH	4	18.5	<b>4 042.77</b>
NIS125-100-315/22SWH	4	22	<b>4 278.62</b>
NIS125-100-315/30SWH	4	30	<b>5 254.85</b>
NIS125-100-200G/4SWH	4	4	<b>1 807.17</b>
NIS125-100-200G/5.5SWH	4	5.5	<b>2 278.44</b>
NIS125-100-200G/7.5SWH	4	7.5	<b>2 351.03</b>
NIS125-100-250G/11SWH	4	11	<b>4 036.33</b>
NIS125-100-315G/15SWH	4	15	<b>4 441.25</b>
NIS125-100-315G/18.5SWH	4	18.5	<b>4 042.77</b>
NIS125-100-400G/30SWH	4	30	<b>5 619.40</b>
NIS125-100-400G/37SWH	4	37	<b>6 192.18</b>
NIS125-100-400G/45SWH	4	45	<b>7 272.01</b>
NIS300-250-250/45SWH	4	45	<b>10 187.02</b>
NIS300-250-250/55SWH	4	55	<b>по запросу</b>
NIS300-250-250/75SWH	4	75	
NIS300-250-315(Q)/75SWH	4	75	
NIS300-250-315(Q)/90SWH	4	90	
NIS300-250-315(Q)/110SWH	4	110	
NIS300-250-400/132SWH	4	132	
NIS300-250-400/160SWH	4	160	
NIS300-250-400/200SWH	4	200	
NIS300-250-315/75SWH	4	75	
NIS300-250-315/90SWH	4	90	
NIS300-250-315/110SWH	4	110	
NIS300-250-400(Q)/110SWH	4	110	
NIS300-250-400(Q)/132SWH	4	132	
NIS300-250-400(Q)/160SWH	4	160	
NIS300-250-400(Q)/200SWH	4	200	
NIS150-125-400(Q)/37SWH	4	37	
NIS150-125-315(Q)/30SWH	4	30	<b>6 556.29</b>
NIS150-125-315(Q)/22SWH	4	22	<b>5 393.36</b>
NIS200-150-250(Q)/11SWH	4	11	<b>4 389.41</b>
NIS200-150-250(Q)/15SWH	4	15	<b>4 603.67</b>
NIS200-150-250(Q)/18.5SWH	4	18.5	<b>5 396.71</b>
NIS200-150-250(Q)/22SWH	4	22	<b>5 656.99</b>
NIS125-100-200(Q)/30SWH	4	30	<b>5 496.31</b>
NIS125-100-200(Q)/37SWH	4	37	<b>5 908.93</b>
NIS150-125-200(Q)/5.5SWH	4	5.5	<b>3 119.77</b>
NIS150-125-200(Q)/7.5SWH	4	7.5	<b>3 211.40</b>
NIS150-125-200(Q)/11SWH	4	11	<b>3 855.45</b>
NIS350-300-250-75SWH	4	75	<b>по запросу</b>
NIS350-300-250-90SWH	4	90	
NIS350-300-250-110SWH	4	110	
NIS350-300-250-132SWH	4	132	
NIS350-300-315-132SWH	4	132	
NIS350-300-315-160SWH	4	160	
NIS350-300-315-185SWH	4	185	
NIS350-300-315-200SWH	4	200	



## NISF центробежные консольно-моноблочные насосы из нерж. стали

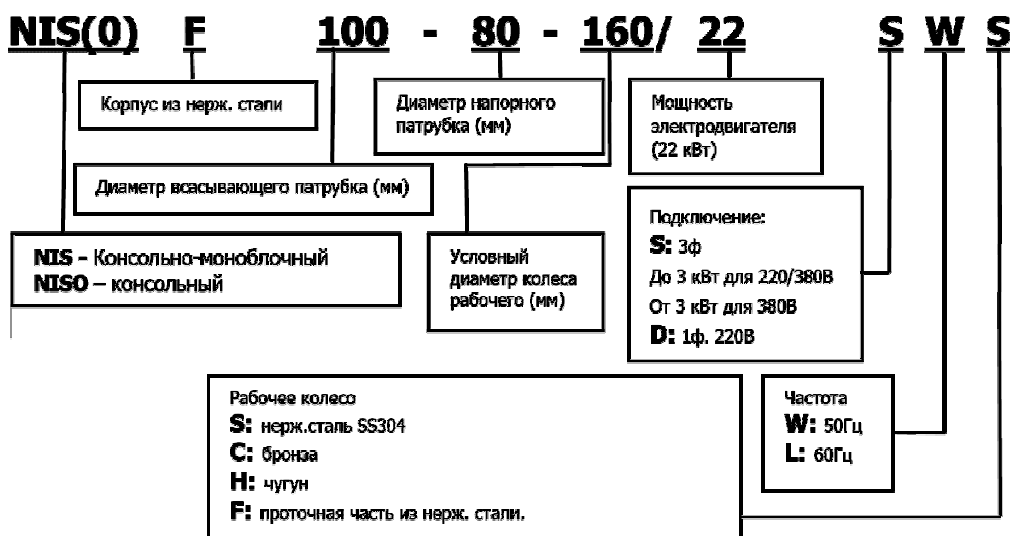

1. Цены в прайсе даны для насосов с двигателем 50Гц/ 380В
2. Материал: корпус насоса SS304, SS316+35% к цене насоса из SS304

обновление 15.02.2023

№ п/п	Модель/Артикул	Кол-во полюсов	Мощность (кВт)	Цена розница (USD) с НДС
1	NISF50-32-160/3SWF	2	3	1 990.03
2	NISF50-32-160/4SWF	2	4	2 166.13
3	NISF50-32-160/5.5SWF	2	5.5	2 561.45
4	NISF50-32-200/7.5SWF	2	7.5	3 122.35
5	NISF50-32-200/11SWF	2	11	3 843.99
6	NISF50-32-160/0.55SWF	4	0.55	1 674.80
7	NISF50-32-200/1.5SWF	4	1.5	2 333.58
8	NISF50-32-160/0.75SWF	4	0.75	1 682.79
11	NISF65-40-200/11SWF	2	11	3 941.87
12	NISF65-40-200/15SWF	2	15	4 145.67
13	NISF65-40-315/22SWF	2	22	6 543.32

14	NISF65-40-315/30SWF	2	30	7 822.21
15	NISF65-40-315/37SWF	2	37	8 245.22
16	NISF65-40-315/45SWF	2	45	9 740.80
17	NISF65-40-250/18.5SWF	2	18.5	5 228.13
18	NISF65-40-250/22SWF	2	22	5 878.32
19	NISF65-40-250/30SWF	2	30	7 169.51
20	NISF65-40-250/3SWF	4	3	3 475.80
21	NISF65-40-200/1.5SWF	4	1.5	2 436.43
22	NISF65-40-200/1.1SWF	4	1.1	2 379.76
23	NISF65-40-200/2.2SWF	4	2.2	2 578.66
24	NISF65-40-315/4SWF	4	4	4 337.20
25	NISF65-40-315/5.5SWF	4	5.5	4 912.27
26	NISF65-50-160/4SWF	2	4	2 265.89
27	NISF65-50-160/5.5SWF	2	5.5	2 666.08
28	NISF65-50-160/7.5SWF	2	7.5	2 714.10
29	NISF65-50-160/1.1SWF	4	1.1	1 884.12
30	NISF65-50-160/0.55SWF	4	0.55	1 784.39
31	NISF65-50-160/0.75SWF	4	0.75	1 788.08
32	NISF80-50-200/11SWF	2	11	4 090.90
33	NISF80-50-200/15SWF	2	15	4 295.29
34	NISF80-50-200/18.5SWF	2	18.5	4 465.90
35	NISF80-50-200/22SWF	2	22	5 259.54
36	NISF80-50-315/37SWF	2	37	8 594.93
37	NISF80-50-315/45SWF	2	45	10 070.83
38	NISF80-50-315/55SWF	2	55	по запросу
39	NISF80-50-315/75SWF	2	75	
40	NISF80-50-250/30SWF	2	30	7 064.22
41	NISF80-50-250/37SWF	2	37	7 496.48
42	NISF80-50-200/1.5SWF	4	1.5	2 586.06
43	NISF80-50-200/3SWF	4	3	2 789.85
44	NISF80-50-315/7.5SWF	4	7.5	5 347.59
45	NISF80-50-200/2.2SWF	4	2.2	2 728.28
46	NISF80-50-315/5.5SWF	4	5.5	5 261.38
47	NISF80-50-250/5.5SWF	4	5.5	4 141.39
48	NISF80-50-250/4SWF	4	4	3 573.06
49	NISF80-65-160/1.5SWF	4	1.5	2 055.32
50	NISF80-65-160/5.5SWF	2	5.5	2 801.56
51	NISF80-65-160/7.5SWF	2	7.5	2 832.97
52	NISF80-65-160/11SWF	2	11	3 574.90
53	NISF80-65-160/15SWF	2	15	3 779.32
54	NISF80-65-160/1.1SWF	4	1.1	1 999.90
55	NISF80-65-160/0.75SWF	4	0.75	1 907.54
56	NISF100-65-200/5.5SWF	4	5.5	4 191.26

57	NISF100-65-200/18.5SWF	2	18.5	5 153.63
58	NISF100-65-200/22SWF	2	22	5 803.86
59	NISF100-65-200/30SWF	2	30	7 093.17
60	NISF100-65-200/37SWF	2	37	7 525.43
61	NISF100-65-315/110SWF	2	110	по запросу
62	NISF100-65-315/90SWF	2	90	
63	NISF100-65-250/45SWF	2	45	9 626.27
64	NISF100-65-250/55SWF	2	55	по запросу
65	NISF100-65-250/75SWF	2	75	
66	NISF100-65-250/7.5SWF	4	7.5	4 869.18
67	NISF100-65-315/11SWF	4	11	6 555.66
68	NISF100-65-200/3SWF	4	3	3 398.21
69	NISF100-65-315/15SWF	4	15	6 771.79
70	NISF100-65-200/4SWF	4	4	3 602.60
71	NISF100-65-250/5.5SWF	4	5.5	4 775.57
72	NISF100-80-160/1.5SWF	4	1.5	2 379.76
73	NISF100-80-160/2.2SWF	4	2.2	2 538.03
74	NISF100-80-160/3SWF	4	3	2 598.98
75	NISF100-80-160/11SWF	2	11	3 975.75
76	NISF100-80-160/15SWF	2	15	4 180.76
77	NISF100-80-160/18.5SWF	2	18.5	4 331.64
78	NISF100-80-160/22SWF	2	22	4 997.89
79	NISF125-80-400/15SWF	4	15	8 883.71
80	NISF125-80-400/18.5SWF	4	18.5	9 525.92
81	NISF125-80-400/22SWF	4	22	9 784.54
82	NISF125-80-400/30SWF	4	30	11 072.60
83	NISF125-80-400/37SWF	4	37	11 649.59
84	NISF125-100-200/5.5SWF	4	5.5	4 829.78
85	NISF125-100-200/7.5SWF	4	7.5	4 919.04
86	NISF125-100-200/11SWF	4	11	5 524.94
87	NISF125-100-200/30SWF	2	30	7 690.41
88	NISF125-100-200/37SWF	2	37	8 123.30
89	NISF125-100-200/45SWF	2	45	9 682.94
90	NISF125-100-200/55SWF	2	55	по запросу
91	NISF125-100-200/75SWF	2	75	
92	NISF125-100-250/90SWF	2	90	
93	NISF125-100-315/110SWF	2	110	
94	NISF125-100-315/132SWF	2	132	
95	NISF125-100-315/160SWF	2	160	
96	NISF125-100-315/22SWF	4	22	8 600.48
97	NISF125-100-315/30SWF	4	30	9 927.36
98	NISF125-100-315/90SWF	2	90	по запросу
99	NISF125-100-400/30SWF	4	30	11 480.23

100	NISF125-100-400/37SWF	4	37	12 253.60
101	NISF125-100-400/45SWF	4	45	13 538.61
102	NISF125-100-250/75SWF	2	75	по запросу
103	NISF125-100-250/110SWF	2	110	
104	NISF125-100-250/15SWF	4	15	7 038.37
105	NISF125-100-315/18.5SWF	4	18.5	8 354.82
106	NISF125-100-315/11SWF	4	11	7 476.16
107	NISF125-100-200/4SWF	4	4	4 234.34
108	NISF150-125-315/30SWF	4	30	10 514.77
109	NISF150-125-315/37SWF	4	37	11 277.65
110	NISF150-125-400/45SWF	4	45	13 855.12
111	NISF150-125-250/18.5SWF	4	18.5	8 060.51
112	NISF150-125-250/22SWF	4	22	8 293.84
113	NISF150-125-250/11SWF	4	11	7 167.67
114	NISF150-125-250/15SWF	4	15	7 442.90
115	NISF150-125-400/55SWF	4	55	по запросу
116	NISF150-125-400/75SWF	4	75	
117	NISF200-150-315/37SWF	4	37	13 054.64
118	NISF200-150-315/45SWF	4	45	14 352.01
119	NISF200-150-315/55SWF	4	55	по запросу
120	NISF200-150-315/75SWF	4	75	
121	NISF200-150-250/30SWF	4	30	10 289.43
122	NISF200-150-400/75SWF	4	75	по запросу
123	NISF200-150-400/90SWF	4	90	
124	NISF200-150-400/110SWF	4	110	
125	NISF250-200-315/37SWF	4	37	14 272.58
126	NISF250-200-315/45SWF	4	45	15 569.91
127	NISF250-200-315/55SWF	4	55	по запросу
128	NISF250-200-315/75SWF	4	75	
129	NISF250-200-400/90SWF	4	90	
130	NISF250-200-400/110SWF	4	110	
131	NISF250-200-400/160SWF	4	160	по запросу
132	NISF250-200-400/132SWF	4	132	
133	NISF300-250-400(Q)/110SWF	4	110	
134	NISF300-250-400(Q)/132SWF	4	132	
135	NISF300-250-400(Q)/160SWF	4	160	
136	NISF300-250-400(Q)/200SWF	4	200	
137	NISF300-250-400/132SWF	4	132	
138	NISF300-250-400/160SWF	4	160	
139	NISF300-250-400/200SWF	4	200	
140	NISF300-250-315(Q)/75SWF	4	75	
141	NISF300-250-315(Q)/90SWF	4	90	
142	NISF300-250-315(Q)/110SWF	4	110	

143	NISF300-250-315/75SWF	4	75
144	NISF300-250-315/90SWF	4	90
145	NISF300-250-315/110SWF	4	110



обновление  
15.02.2023

## NISO центробежные консольные насосы

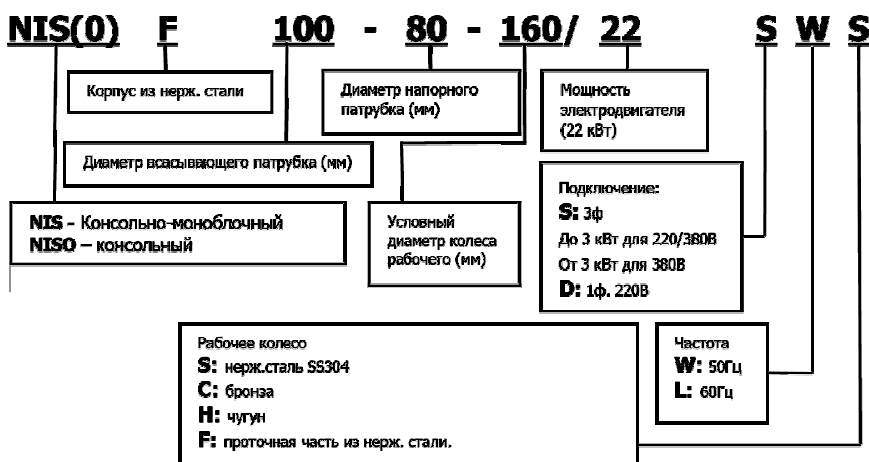

Проточн. часть - чугун НТ200, рабочее колесо- чугун НТ200		Проточн. часть - чугун НТ200, рабочее колесо- нержавеющая сталь 304		Проточн. часть - ковкий чугун, рабочее колесо- чугун НТ200		Мощность, кВт
Артикул	Цена розница (USD) с НДС	Артикул	Цена розница (USD) с НДС	Артикул	Цена розница (USD) с НДС	
<b>2-х полюсной электродвигатель</b>						
NIS050-32-160/3SWH	1 361.64	NIS050-32-160/3SWS	1 572.60	NIS050-32-160/3SWH DI	1 460.18	3
NIS050-32-160/4SWH	1 500.47	NIS050-32-160/4SWS	1 718.95	NIS050-32-160/4SWH DI	1 608.18	4
NIS050-32-160/5.5SWH	1 815.48	NIS050-32-160/5.5SWS	2 052.62	NIS050-32-160/5.5SWH DI	1 945.93	5.5
NIS050-32-200/7.5SWH	1 956.10	NIS050-32-200/7.5SWS	2 260.07	NIS050-32-200/7.5SWH DI	2 096.82	7.5
NIS050-32-200/11SWH	2 393.37	NIS050-32-200/11SWS	2 723.38	NIS050-32-200/11SWH DI	2 565.44	11
NIS065-40-200/7.5SWH	1 956.88	NIS065-40-200/7.5SWS	2 224.90	NIS065-40-200/7.5SWH DI	2 097.96	7.5
NIS065-40-200/11SWH	2 411.91	NIS065-40-200/11SWS	2 707.27	NIS065-40-200/11SWH DI	2 585.99	11
NIS065-40-200/15SWH	2 558.90	NIS065-40-200/15SWS	2 862.83	NIS065-40-200/15SWH DI	2 743.18	15
NIS065-40-250/18.5SWH	2 974.63	NIS065-40-250/18.5SWS	3 413.76	NIS065-40-250/18.5SWH DI	3 188.37	18.5
NIS065-40-250/22SWH	3 419.07	NIS065-40-250/22SWS	3 885.11	NIS065-40-250/22SWH DI	3 665.55	22
NIS065-40-250/30SWH	4 291.63	NIS065-40-250/30SWS	4 810.00	NIS065-40-250/30SWH DI	4 601.08	30
NIS065-40-315/22SWH	3 588.71	NIS065-40-315/22SWS	4 649.39	NIS065-40-315/22SWH DI	3 847.31	22
NIS065-40-315/30SWH	4 422.02	NIS065-40-315/30SWS	5 597.58	NIS065-40-315/30SWH DI	4 740.54	30
NIS065-40-315/37SWH	4 754.16	NIS065-40-315/37SWS	5 975.75	NIS065-40-315/37SWH DI	5 096.59	37
NIS065-40-315/45SWH	5 725.34	NIS065-40-315/45SWS	7 081.13	NIS065-40-315/45SWH DI	6 137.83	45
NIS065-50-160/4SWH	1 519.76	NIS065-50-160/4SWS	1 738.58	NIS065-50-160/4SWH DI	1 629.33	4
NIS065-50-160/5.5SWH	1 834.95	NIS065-50-160/5.5SWS	2 072.82	NIS065-50-160/5.5SWH DI	1 967.65	5.5
NIS065-50-160/7.5SWH	1 870.95	NIS065-50-160/7.5SWS	2 110.83	NIS065-50-160/7.5SWH DI	2 005.94	7.5



NIS080-50-200/11SWH	<b>2 453.89</b>	NIS080-50-200/11SWS	<b>2 747.59</b>	NIS080-50-200/11SWH DI	<b>2 630.01</b>	11
NIS080-50-200/15SWH	<b>2 600.84</b>	NIS080-50-200/15SWS	<b>2 903.76</b>	NIS080-50-200/15SWH DI	<b>2 788.31</b>	15
NIS080-50-200/18.5SWH	<b>2 752.75</b>	NIS080-50-200/18.5SWS	<b>3 064.52</b>	NIS080-50-200/18.5SWH DI	<b>2 950.62</b>	18.5
NIS080-50-200/22SWH	<b>3 197.85</b>	NIS080-50-200/22SWS	<b>3 536.47</b>	NIS080-50-200/22SWH DI	<b>3 428.40</b>	22
NIS080-50-250/30SWH	<b>4 362.07</b>	NIS080-50-250/30SWS	<b>4 835.95</b>	NIS080-50-250/30SWH DI	<b>4 675.97</b>	30
NIS080-50-250/37SWH	<b>4 694.21</b>	NIS080-50-250/37SWS	<b>5 187.47</b>	NIS080-50-250/37SWH DI	<b>5 031.99</b>	37
NIS080-50-315/37SWH	<b>4 848.79</b>	NIS080-50-315/37SWS	<b>6 097.68</b>	NIS080-50-315/37SWH DI	<b>5 197.16</b>	37
NIS080-50-315/45SWH	<b>5 811.15</b>	NIS080-50-315/45SWS	<b>7 193.80</b>	NIS080-50-315/45SWH DI	<b>6 229.85</b>	45
NIS080-50-315/55SWH	<b>по запросу</b>	NIS080-50-315/55SWS	<b>по запросу</b>	NIS080-50-315/55SWH DI	<b>по запросу</b>	55
NIS080-50-315/75SWH		NIS080-50-315/75SWS		NIS080-50-315/75SWH DI		75
NIS080-65-160/5.5SWH	<b>1 920.22</b>	NIS080-65-160/5.5SWS	<b>2 129.82</b>	NIS080-65-160/5.5SWH DI	<b>2 059.10</b>	5.5
NIS080-65-160/7.5SWH	<b>1 956.25</b>	NIS080-65-160/7.5SWS	<b>2 167.30</b>	NIS080-65-160/7.5SWH DI	<b>2 096.82</b>	7.5
NIS080-65-160/11SWH	<b>2 412.84</b>	NIS080-65-160/11SWS	<b>2 651.91</b>	NIS080-65-160/11SWH DI	<b>2 587.16</b>	11
NIS080-65-160/15SWH	<b>2 559.83</b>	NIS080-65-160/15SWS	<b>2 807.54</b>	NIS080-65-160/15SWH DI	<b>2 744.32</b>	15
NIS0100-65-200/18.5SWH	<b>3 084.14</b>	NIS0100-65-200/18.5SWS	<b>3 447.18</b>	NIS0100-65-200/18.5SWH DI	<b>3 306.07</b>	18.5
NIS0100-65-200/22SWH	<b>3 529.99</b>	NIS0100-65-200/22SWS	<b>3 919.70</b>	NIS0100-65-200/22SWH DI	<b>3 784.42</b>	22
NIS0100-65-200/30SWH	<b>4 407.62</b>	NIS0100-65-200/30SWS	<b>4 849.21</b>	NIS0100-65-200/30SWH DI	<b>4 724.55</b>	30
NIS0100-65-200/37SWH	<b>4 739.76</b>	NIS0100-65-200/37SWS	<b>5 201.84</b>	NIS0100-65-200/37SWH DI	<b>5 081.14</b>	37
NIS0100-65-250/45SWH	<b>5 943.10</b>	NIS0100-65-250/45SWS	<b>6 607.92</b>	NIS0100-65-250/45SWH DI	<b>6 371.58</b>	45
NIS0100-65-250/55SWH	<b>по запросу</b>	NIS0100-65-250/55SWS	<b>по запросу</b>	NIS0100-65-250/55SWH DI	<b>по запросу</b>	55
NIS0100-65-250/75SWH		NIS0100-65-250/75SWS		NIS0100-65-250/75SWH DI		75
NIS0100-65-315/90SWH		NIS0100-65-315/90SWS		NIS0100-65-315/90SWH DI		90
NIS0100-65-315/110SWH		NIS0100-65-315/110SWS		NIS0100-65-315/110SWH DI		110
NIS0100-80-160/11SWH	<b>2 642.82</b>	NIS0100-80-160/11SWS	<b>2 915.85</b>	NIS0100-80-160/11SWH DI	<b>2 832.89</b>	11
NIS0100-80-160/15SWH	<b>2 789.81</b>	NIS0100-80-160/15SWS	<b>3 071.42</b>	NIS0100-80-160/15SWH DI	<b>2 990.62</b>	15
NIS0100-80-160/18.5SWH	<b>2 933.55</b>	NIS0100-80-160/18.5SWS	<b>3 224.14</b>	NIS0100-80-160/18.5SWH DI	<b>3 144.93</b>	18.5
NIS0100-80-160/22SWH	<b>3 401.40</b>	NIS0100-80-160/22SWS	<b>3 719.73</b>	NIS0100-80-160/22SWH DI	<b>3 646.13</b>	22
NIS0125-100-200/30SWH	<b>4 547.35</b>	NIS0125-100-200/30SWS	<b>5 025.51</b>	NIS0125-100-200/30SWH DI	<b>4 874.26</b>	30
NIS0125-100-200/37SWH	<b>4 879.51</b>	NIS0125-100-200/37SWS	<b>5 378.20</b>	NIS0125-100-200/37SWH DI	<b>5 230.88</b>	37
NIS0125-100-200/45SWH	<b>5 954.90</b>	NIS0125-100-200/45SWS	<b>6 517.46</b>	NIS0125-100-200/45SWH DI	<b>6 383.58</b>	45
NIS0125-100-200/55SWH	<b>по запросу</b>	NIS0125-100-200/55SWS	<b>по запросу</b>	NIS0125-100-200/55SWH DI	<b>по запросу</b>	55
NIS0125-100-200/75SWH		NIS0125-100-200/75SWS		NIS0125-100-200/75SWH DI		75
NIS0125-100-250/75SWH		NIS0125-100-250/75SWS		NIS0125-100-250/75SWH DI		75
NIS0125-100-250/90SWH		NIS0125-100-250/90SWS		NIS0125-100-250/90SWH DI		90
NIS0125-100-250/110SWH		NIS0125-100-250/110SWS		NIS0125-100-250/110SWH DI		110
NIS0125-100-315/90SWH		NIS0125-100-315/90SWS		NIS0125-100-315/90SWH DI		90
NIS0125-100-315/110SWH		NIS0125-100-315/110SWS		NIS0125-100-315/110SWH DI		110
NIS0125-100-315/132SWH		NIS0125-100-315/132SWS		NIS0125-100-315/132SWH DI		132
NIS0125-100-315/160SWH		NIS0125-100-315/160SWS		NIS0125-100-315/160SWH DI		160
<b>4-х полюсной электродвигатель</b>						
NIS050-32-160/0.55SWH	<b>1 131.67</b>	NIS050-32-160/0.55SWS	<b>1 328.28</b>	NIS050-32-160/0.55SWH DI	<b>1 213.28</b>	0.55
NIS050-32-160/0.75SWH	<b>1 138.87</b>	NIS050-32-160/0.75SWS	<b>1 335.75</b>	NIS050-32-160/0.75SWH DI	<b>1 220.72</b>	0.75
NIS050-32-200/1.1SWH	<b>1 287.15</b>	NIS050-32-200/1.1SWS	<b>1 551.27</b>	NIS050-32-200/1.1SWH DI	<b>1 379.59</b>	1.1
NIS050-32-200/1.5SWH	<b>1 337.82</b>	NIS050-32-200/1.5SWS	<b>1 604.88</b>	NIS050-32-200/1.5SWH DI	<b>1 433.86</b>	1.5
NIS065-40-200/1.1SWH	<b>1 295.01</b>	NIS065-40-200/1.1SWS	<b>1 523.06</b>	NIS065-40-200/1.1SWH DI	<b>1 388.17</b>	1.1
NIS065-40-200/1.5SWH	<b>1 350.30</b>	NIS065-40-200/1.5SWS	<b>1 581.84</b>	NIS065-40-200/1.5SWH DI	<b>1 447.60</b>	1.5
NIS065-40-200/2.2SWH	<b>1 452.58</b>	NIS065-40-200/2.2SWS	<b>1 690.15</b>	NIS065-40-200/2.2SWH DI	<b>1 556.76</b>	2.2
NIS065-40-250/3SWH	<b>1 789.82</b>	NIS065-40-250/3SWS	<b>2 158.65</b>	NIS065-40-250/3SWH DI	<b>1 919.08</b>	3
NIS065-40-315/4SWH	<b>2 132.97</b>	NIS065-40-315/4SWS	<b>2 992.51</b>	NIS065-40-315/4SWH DI	<b>2 286.56</b>	4
NIS065-40-315/5.5SWH	<b>2 453.20</b>	NIS065-40-315/5.5SWS	<b>3 356.45</b>	NIS065-40-315/5.5SWH DI	<b>2 629.44</b>	5.5
NIS065-50-160/0.55SWH	<b>1 150.75</b>	NIS065-50-160/0.55SWS	<b>1 347.27</b>	NIS065-50-160/0.55SWH DI	<b>1 233.29</b>	0.55
NIS065-50-160/0.75SWH	<b>1 161.49</b>	NIS065-50-160/0.75SWS	<b>1 358.79</b>	NIS065-50-160/0.75SWH DI	<b>1 245.29</b>	0.75
NIS065-50-160/1.1SWH	<b>1 238.60</b>	NIS065-50-160/1.1SWS	<b>1 440.64</b>	NIS065-50-160/1.1SWH DI	<b>1 328.16</b>	1.1

NISO80-50-200/1.5SWH	<b>1 400.20</b>	NISO80-50-200/1.5SWS	<b>1 631.37</b>	NISO80-50-200/1.5SWH DI	<b>1 501.31</b>	1.5
NISO80-50-200/2.2SWH	<b>1 502.78</b>	NISO80-50-200/2.2SWS	<b>1 740.29</b>	NISO80-50-200/2.2SWH DI	<b>1 611.03</b>	2.2
NISO80-50-200/3SWH	<b>1 562.28</b>	NISO80-50-200/3SWS	<b>1 803.08</b>	NISO80-50-200/3SWH DI	<b>1 674.49</b>	3
NISO80-50-250/4SWH	<b>1 996.10</b>	NISO80-50-250/4SWS	<b>2 262.98</b>	NISO80-50-250/4SWH DI	<b>2 139.66</b>	4
NISO80-50-250/5.5SWH	<b>2 363.79</b>	NISO80-50-250/5.5SWS	<b>2 652.51</b>	NISO80-50-250/5.5SWH DI	<b>2 534.00</b>	5.5
NISO80-50-315/5.5SWH	<b>2 586.29</b>	NISO80-50-315/5.5SWS	<b>3 522.94</b>	NISO80-50-315/5.5SWH DI	<b>2 772.31</b>	5.5
NISO80-50-315/7.5SWH	<b>2 663.43</b>	NISO80-50-315/7.5SWS	<b>3 610.82</b>	NISO80-50-315/7.5SWH DI	<b>2 855.18</b>	7.5
NISO80-65-160/0.75SWH	<b>1 221.65</b>	NISO80-65-160/0.75SWS	<b>1 388.77</b>	NISO80-65-160/0.75SWH DI	<b>1 309.29</b>	0.75
NISO80-65-160/1.1SWH	<b>1 301.70</b>	NISO80-65-160/1.1SWS	<b>1 474.04</b>	NISO80-65-160/1.1SWH DI	<b>1 395.58</b>	1.1
NISO80-65-160/1.5SWH	<b>1 357.26</b>	NISO80-65-160/1.5SWS	<b>1 532.81</b>	NISO80-65-160/1.5SWH DI	<b>1 455.01</b>	1.5
NISO100-65-200/3SWH	<b>1 891.68</b>	NISO100-65-200/3SWS	<b>2 183.44</b>	NISO100-65-200/3SWH DI	<b>2 028.23</b>	3
NISO100-65-200/4SWH	<b>2 052.77</b>	NISO100-65-200/4SWS	<b>2 354.01</b>	NISO100-65-200/4SWH DI	<b>2 200.81</b>	4
NISO100-65-200/5.5SWH	<b>2 421.78</b>	NISO100-65-200/5.5SWS	<b>2 745.28</b>	NISO100-65-200/5.5SWH DI	<b>2 596.28</b>	5.5
NISO100-65-250/5.5SWH	<b>2 528.72</b>	NISO100-65-250/5.5SWS	<b>2 989.06</b>	NISO100-65-250/5.5SWH DI	<b>2 710.60</b>	5.5
NISO100-65-250/7.5SWH	<b>2 652.12</b>	NISO100-65-250/7.5SWS	<b>3 119.84</b>	NISO100-65-250/7.5SWH DI	<b>2 843.18</b>	7.5
NISO100-65-315/11SWH	<b>3 446.01</b>	NISO100-65-315/11SWS	<b>3 787.75</b>	NISO100-65-315/11SWH DI	<b>3 694.14</b>	11
NISO100-65-315/15SWH	<b>3 611.96</b>	NISO100-65-315/15SWS	<b>3 963.48</b>	NISO100-65-315/15SWH DI	<b>3 871.88</b>	15
NISO100-80-160/1.5SWH	<b>1 670.95</b>	NISO100-80-160/1.5SWS	<b>1 886.10</b>	NISO100-80-160/1.5SWH DI	<b>1 791.05</b>	1.5
NISO100-80-160/2.2SWH	<b>1 775.93</b>	NISO100-80-160/2.2SWS	<b>1 997.30</b>	NISO100-80-160/2.2SWH DI	<b>1 903.66</b>	2.2
NISO100-80-160/3SWH	<b>1 835.67</b>	NISO100-80-160/3SWS	<b>2 060.69</b>	NISO100-80-160/3SWH DI	<b>1 968.22</b>	3
NISO125-100-200/4SWH	<b>2 199.13</b>	NISO125-100-200/4SWS	<b>2 537.84</b>	NISO125-100-200/4SWH DI	<b>2 357.97</b>	4
NISO125-100-200/5.5SWH	<b>2 544.26</b>	NISO125-100-200/5.5SWS	<b>2 903.19</b>	NISO125-100-200/5.5SWH DI	<b>2 727.73</b>	5.5
NISO125-100-200/7.5SWH	<b>2 663.94</b>	NISO125-100-200/7.5SWS	<b>3 029.95</b>	NISO125-100-200/7.5SWH DI	<b>2 855.75</b>	7.5
NISO125-100-200/11SWH	<b>2 973.10</b>	NISO125-100-200/11SWS	<b>3 357.83</b>	NISO125-100-200/11SWH DI	<b>3 187.23</b>	11
NISO125-100-250/15SWH	<b>3 649.04</b>	NISO125-100-250/15SWS	<b>4 207.83</b>	NISO125-100-250/15SWH DI	<b>3 911.87</b>	15
NISO125-100-315/11SWH	<b>3 626.63</b>	NISO125-100-315/11SWS	<b>4 260.24</b>	NISO125-100-315/11SWH DI	<b>3 887.30</b>	11
NISO125-100-315/18.5SWH	<b>4 232.70</b>	NISO125-100-315/18.5SWS	<b>4 902.77</b>	NISO125-100-315/18.5SWH DI	<b>4 537.65</b>	18.5
NISO125-100-315/22SWH	<b>4 391.96</b>	NISO125-100-315/22SWS	<b>5 071.63</b>	NISO125-100-315/22SWH DI	<b>4 708.52</b>	22
NISO125-100-315/30SWH	<b>5 305.59</b>	NISO125-100-315/30SWS	<b>6 039.74</b>	NISO125-100-315/30SWH DI	<b>5 687.50</b>	30
NISO125-80-400/15SWH	<b>3 919.49</b>	NISO125-80-400/15SWS	<b>5 584.59</b>	NISO125-80-400/15SWH DI	<b>4 201.62</b>	15
NISO125-80-400/18.5SWH	<b>4 366.01</b>	NISO125-80-400/18.5SWS	<b>6 092.73</b>	NISO125-80-400/18.5SWH DI	<b>4 680.53</b>	18.5
NISO125-80-400/22SWH	<b>4 568.05</b>	NISO125-80-400/22SWS	<b>6 322.35</b>	NISO125-80-400/22SWH DI	<b>4 896.56</b>	22
NISO125-80-400/30SWH	<b>5 527.20</b>	NISO125-80-400/30SWS	<b>7 414.74</b>	NISO125-80-400/30SWH DI	<b>5 925.25</b>	30
NISO125-80-400/37SWH	<b>5 968.16</b>	NISO125-80-400/37SWS	<b>7 916.70</b>	NISO125-80-400/37SWH DI	<b>6 398.44</b>	37
NISO125-100-400/30SWH	<b>5 689.64</b>	NISO125-100-400/30SWS	<b>6 387.30</b>	NISO125-100-400/30SWH DI	<b>6 098.97</b>	30
NISO125-100-400/37SWH	<b>6 090.66</b>	NISO125-100-400/37SWS	<b>8 066.47</b>	NISO125-100-400/37SWH DI	<b>6 529.31</b>	37
NISO125-100-400/45SWH	<b>7 123.17</b>	NISO125-100-400/45SWS	<b>9 241.20</b>	NISO125-100-400/45SWH DI	<b>7 635.72</b>	45
NISO150-125-250/22SWH	<b>4 480.08</b>	NISO150-125-250/22SWS	<b>5 085.46</b>	NISO150-125-250/22SWH DI	<b>4 802.82</b>	22
NISO150-125-250/18.5SWH	<b>4 317.76</b>	NISO150-125-250/18.5SWS	<b>4 918.91</b>	NISO150-125-250/18.5SWH DI	<b>4 628.53</b>	18.5
NISO150-125-250/15SWH	<b>3 906.38</b>	NISO150-125-250/15SWS	<b>4 483.26</b>	NISO150-125-250/15SWH DI	<b>4 187.90</b>	15
NISO150-125-250/11SWH	<b>3 727.68</b>	NISO150-125-250/11SWS	<b>4 293.70</b>	NISO150-125-250/11SWH DI	<b>3 995.88</b>	11
NISO150-125-315/37SWH	<b>6 223.73</b>	NISO150-125-315/37SWS	<b>7 467.13</b>	NISO150-125-315/37SWH DI	<b>6 672.19</b>	37
NISO150-125-315/30SWH	<b>5 858.46</b>	NISO150-125-315/30SWS	<b>7 079.87</b>	NISO150-125-315/30SWH DI	<b>6 280.13</b>	30
NISO150-125-400/75SWH	<b>по запросу</b>	NISO150-125-400/75SWS	<b>по запросу</b>	NISO150-125-400/75SWH DI	<b>по запросу</b>	75
NISO150-125-400/55SWH		NISO150-125-400/55SWS		NISO150-125-400/55SWH DI		55
NISO150-125-400/45SWH	<b>7 597.73</b>	NISO150-125-400/45SWS	<b>8 877.80</b>	NISO150-125-400/45SWH DI	<b>8 144.36</b>	45
NISO200-150-315/75SWH	<b>по запросу</b>	NISO200-150-315/75SWS	<b>по запросу</b>	NISO200-150-315/75SWH DI	<b>по запросу</b>	75
NISO200-150-315/55SWH		NISO200-150-315/55SWS		NISO200-150-315/55SWH DI		55
NISO200-150-315/45SWH	<b>8 420.87</b>	NISO200-150-315/45SWS	<b>9 889.69</b>	NISO200-150-315/45SWH DI	<b>8 651.18</b>	45
NISO200-150-315/37SWH	<b>7 572.35</b>	NISO200-150-315/37SWS	<b>8 990.76</b>	NISO200-150-315/37SWH DI	<b>7 779.82</b>	37
NISO200-150-400/110SWH	<b>по запросу</b>	NISO200-150-400/110SWS	<b>по запросу</b>	NISO200-150-400/110SWH DI	<b>по запросу</b>	110
NISO200-150-400/90SWH		NISO200-150-400/90SWS		NISO200-150-400/90SWH DI		90
NISO200-150-400/75SWH		NISO200-150-400/75SWS		NISO200-150-400/75SWH DI		75
NISO250-200-315/37SWH		NISO250-200-315/37SWS		NISO250-200-315/37SWH DI		37
	<b>8 882.39</b>		<b>9 746.37</b>		<b>8 536.27</b>	

NIS0250-200-315/45SWH	<b>9 833.98</b>	NIS0250-200-315/45SWS	<b>10 680.91</b>	NIS0250-200-315/45SWH DI	<b>9 450.38</b>	45
NIS0250-200-315/55SWH	<b>по запросу</b>	NIS0250-200-315/55SWS	<b>по запросу</b>	NIS0250-200-315/55SWH DI	<b>по запросу</b>	55
NIS0250-200-315/75SWH		NIS0250-200-315/75SWS		NIS0250-200-315/75SWH DI		75
NIS0250-200-400/90SWH		NIS0250-200-400/90SWS		NIS0250-200-400/90SWH DI		90
NIS0250-200-400/110SWH		NIS0250-200-400/110SWS		NIS0250-200-400/110SWH DI		110
NIS0250-200-400/132SWH		NIS0250-200-400/132SWS		NIS0250-200-400/132SWH DI		132
NIS0250-200-400/160SWH		NIS0250-200-400/160SWS		NIS0250-200-400/160SWH DI		160
NIS0300-250-315(Q)/75SWH		NIS0300-250-315(Q)/75SWS		NIS0300-250-315(Q)/75SWH DI		75
NIS0300-250-315(Q)/90SWH		NIS0300-250-315(Q)/90SWS		NIS0300-250-315(Q)/90SWH DI		90
NIS0300-250-315(Q)/110SWH		NIS0300-250-315(Q)/110SWS		NIS0300-250-315(Q)/110SWH DI		110
NIS0300-250-315/75SWH		NIS0300-250-315/75SWS		NIS0300-250-315/75SWH DI		75
NIS0300-250-315/90SWH		NIS0300-250-315/90SWS		NIS0300-250-315/90SWH DI		90
NIS0300-250-315/110SWH		NIS0300-250-315/110SWS		NIS0300-250-315/110SWH DI		110
NIS0300-250-400/132SWH		NIS0300-250-400/132SWS		NIS0300-250-400/132SWH DI		132
NIS0300-250-400/160SWH		NIS0300-250-400/160SWS		NIS0300-250-400/160SWH DI		160
NIS0300-250-400/200SWH		NIS0300-250-400/200SWS		NIS0300-250-400/200SWH DI		200
NIS0300-250-400(Q)/110SWH		NIS0300-250-400(Q)/110SWS		NIS0300-250-400(Q)/110SWH DI		110
NIS0300-250-400(Q)/132SWH		NIS0300-250-400(Q)/132SWS		NIS0300-250-400(Q)/132SWH DI		132
NIS0300-250-400(Q)/160SWH		NIS0300-250-400(Q)/160SWS		NIS0300-250-400(Q)/160SWH DI		160
NIS0300-250-400(Q)/200SWH		NIS0300-250-400(Q)/200SWS		NIS0300-250-400(Q)/200SWH DI		200



## ZS центробежные моноблочные штампованные насосы

Материал изготовления нержавеющей сталь SS304.

обновление 15.02.2023

Модель	Артикул	Цена розница (USD) с НДС
ZS50-32-160/1.1	ZS50-32-160/1.1SSC	1 013.22
ZS50-32-160/1.5	ZS50-32-160/1.5SSC	1 097.08
ZS50-32-160/2.2	ZS50-32-160/2.2SSC	1 143.20
ZS50-32-200/3	ZS50-32-200/3SSC	1 407.33
ZS50-32-200/4	ZS50-32-200/4SSC	1 632.34
ZS50-32-200/5.5	ZS50-32-200/5.5SSC	2 026.45
ZS65-40-125/1.5	ZS65-40-125/1.5SSC	1 126.43
ZS65-40-125/2.2	ZS65-40-125/2.2SSC	1 182.33
ZS65-40-125/3	ZS65-40-125/3SSC	1 463.23
ZS65-40-160/4	ZS65-40-160/4SSC	1 688.24
ZS65-40-200/5.5	ZS65-40-200/5.5SSC	2 082.35
ZS65-40-200/7.5	ZS65-40-200/7.5SSC	2 122.88
ZS65-40-200/11	ZS65-40-200/11SSC	2 500.22
ZS65-50-125/3	ZS65-50-125/3SSC	1 519.14
ZS65-50-125/4	ZS65-50-125/4SSC	1 744.14
ZS65-50-160/5.5	ZS65-50-160/5.5SSC	2 138.25
ZS65-50-200/7.5	ZS65-50-200/7.5SSC	2 194.15
ZS65-50-200/9.2	ZS65-50-200/9.2SSC	2 251.45

Модель	Артикул	Цена розница (USD) с НДС
ZS65-50-200/11	ZS65-50-200/11SSC	2 476.46
ZS65-50-200/15	ZS65-50-200/15SSC	2 644.16
ZS65-50-200/18.5	ZS65-50-200/18.5SSC	2 813.27
ZS80-65-125/5.5	ZS80-65-125/5.5SSC	2 317.14
ZS80-65-125/7.5	ZS80-65-125/7.5SSC	2 366.05
ZS80-65-125/9.2	ZS80-65-125/9.2SSC	2 551.93
ZS80-65-160/11	ZS80-65-160/11SSC	3 185.02
ZS80-65-160/15	ZS80-65-160/15SSC	3 386.26
ZS80-65-200/18.5	ZS80-65-200/18.5SSC	3 667.17
ZS80-65-200/22	ZS80-65-200/22SSC	4 569.99
ZS80-65-200/30	ZS80-65-200/30SSC	5 841.76
ZS100-80-160/11	ZS100-80-160/11SSC	3 182.22
ZS100-80-160/15	ZS100-80-160/15SSC	3 383.47
ZS100-80-160/18.5	ZS100-80-160/18.5SSC	3 546.98
ZS100-80-200/22	ZS100-80-200/22SSC	4 674.80
ZS100-80-200/30	ZS100-80-200/30SSC	5 949.37
ZS100-80-200/37	ZS100-80-200/37SSC	6 409.16

Насосные агрегаты комплектуются двигателями с классом защиты IP55 в стандартном исполнении (по цене агрегата с двигателем IP54)!!!

\* Цена насосов ZS из нержавеющей стали SS316 +30% к цене из SS304.



## MS горизонтальные одноступенчатые центробежные насосы из нержавеющей стали

Цены указаны на насосные агрегаты из нержавеющей стали **SS304**. Стоимость агрегата из **SS316 +30%** к цене соотв. модели.

**обновление 15.02.2023**

3*380V		1*220V		Мощность (кВт)
Артикул	Розница USD с НДС	Артикул	Розница USD с НДС	
MS60/0,75SSC	<b>414.95</b>	MS60/0,75DSC	<b>457.16</b>	0.75
MS60/0,55SSC	<b>337.13</b>	MS60/0,55DSC	<b>368.99</b>	0.55
MS60/0,37SSC	<b>309.74</b>	MS60/0,37DSC	<b>341.60</b>	0.37
MS100/1,1SSC	<b>485.31</b>	MS100/1,1DSC	<b>544.61</b>	1.1
MS100/0,55SSC	<b>331.94</b>	MS100/0,55DSC	<b>363.80</b>	0.55
MS160/1,1SSC	<b>488.30</b>	MS160/1,1DSC	<b>549.04</b>	1.1
MS160/0,75SSC	<b>412.72</b>	MS160/0,75DSC	<b>456.44</b>	0.75
MS250/2,2SSC	<b>591.28</b>	MS250/2,2DSC	<b>635.73</b>	2.2
MS250/1,5SSC	<b>552.03</b>	MS250/1,5DSC	<b>607.57</b>	1.5
MS250/1,1SSC	<b>486.07</b>	MS250/1,1DSC	<b>546.84</b>	1.1
MS330/2,2SSC	<b>591.28</b>	MS330/2,2DSC	<b>635.01</b>	2.2
MS330/1,5SSC	<b>552.03</b>	MS330/1,5DSC	<b>607.57</b>	1.5



## SZ горизонтальные одноступенчатые фторопластовые центробежные насосы



**обновление 15.02.2023**

Фторопласт F26		Фторопласт F46		Мощность (кВт)
Артикул	Роница USD с НДС	Артикул	Роница USD с НДС	
SZ 25-25-125SF26	1 700.86	SZ 25-25-125SF46	2 126.06	1.1
SZ 40-25-125SF26	1 783.40	SZ 40-25-125SF46	2 229.26	1.5
SZ 50-32-125SF26	2 239.99	SZ 50-32-125SF46	2 800.01	3
SZ 50-32-160SF26	2 706.97	SZ 50-32-160SF46	3 383.72	4
SZ 65-50-125SF26	2 777.76	SZ 65-50-125SF46	3 472.20	4
SZ 65-50-160SF26	3 418.49	SZ 65-50-160SF46	4 273.12	5.5
SZ 80-65-125SF26	3 548.35	SZ 80-65-125SF46	4 435.43	7.5
SZ 65-40-200SF26	4 670.43	SZ 65-40-200SF46	5 838.04	11
SZ 80-65-160SF26	4 525.38	SZ 80-65-160SF46	5 656.72	11
SZ 80-50-200SF26	5 289.24	SZ 80-50-200SF46	6 611.56	18.5

Насосные агрегаты комплектуются двигателями с классом защиты IP55 в стандартном исполнении (по цене агрегата с двигателем IP54)!

## WLT высокоэффективные высокорасходные насосы

WLT S 100- 5 A / 2.2 S W S



обновление 15.02.2023

N	Модель/артикул	Мощность, кВт	Q, м3/ч	H, м.вод.ст.	Скорость, об/мин	Цена розница, USD с НДС
1	WLT65-5/1.1SWS	1.1	40	5	2900	<b>734.29</b>
2	WLT80-5/1.5SWS	1.5	55	5	2900	<b>879.50</b>
3	WLT100-5A/2.2SWS	2.2	80	5	1450	<b>1 369.74</b>
4	WLT100-5/2.2SWS	2.2	100	5	1450	<b>1 369.74</b>
5	WLT125-5A/3SWS	3	120	5	1450	<b>1 579.90</b>
6	WLT125-5/4SWS	4	160	5	1450	<b>1 836.87</b>
8	WLT150-6A/5.5SWS	5.5	200	6	1450	<b>2 604.56</b>
9	WLT150-6/7.5SWS	7.5	250	6	1450	<b>2 694.04</b>
<b>WLTS - с удлиненным валом</b>						
10	WLTS65-5/1.1SWS	1.1	40	5	2900	<b>793.99</b>
11	WLTS80-5/1.5SWS	1.5	55	5	2900	<b>952.03</b>
12	WLTS100-5A/2.2SWS	2.2	80	5	1450	<b>1 448.55</b>
13	WLTS100-5/2.2SWS	2.2	100	5	1450	<b>1 448.55</b>
14	WLTS125-5A/3SWS	3	120	5	1450	<b>1 656.94</b>
16	WLTS125-5/4SWS	4	160	5	1450	<b>1 920.57</b>
17	WLTS150-6A/5.5SWS	5.5	200	6	1450	<b>2 735.47</b>
18	WLTS150-6/7.5SWS	7.5	250	6	1450	<b>2 836.12</b>
<b>WLTS - с удлиненным валом, проточная часть из нерж.стали</b>						
19	WLTSF65-5/1.1SWS	1.1	40	5	2900	<b>2 466.20</b>
20	WLTSF65-5/1.1SWS	1.1	40	5	2900	<b>2 466.20</b>
21	WLTSF65-5/1.1SWS	1.1	40	5	2900	<b>2 466.20</b>
22	WLTSF80-5/1.5SWS	1.5	55	5	2900	<b>2 596.11</b>
23	WLTSF100-5A/2.2SWS	2.2	80	5	1450	<b>3 570.27</b>
24	WLTSF100-5/2.2SWS	2.2	120	5	1450	<b>3 570.27</b>
25	WLTSF125-5A/3SWS	3	150	5	1450	<b>4 024.28</b>
26	WLTSF125-5/4SWS	4	180	5	1450	<b>4 413.59</b>
27	WLTSF150-6A/5.5SWS	5.5	220	6	1450	<b>6 231.14</b>
28	WLTSF150-6/7.5SWS	7.5	250	6	1450	<b>6 750.33</b>

Стоимость насосов указана на стандартное исполнение: корпус - чугун; рабочее колесо SS304, двигатель 380В.

Для насосов с однофазным двигателем цена насосов рассчитывается следующим образом: 1.1кВт-35,71 USD, 1.5кВт-51,02 USD, 2.2кВт-61,27 USD



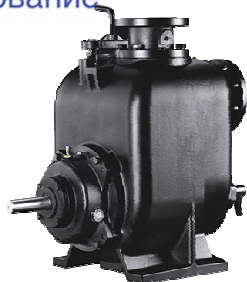

## SP самовсасывающие поверхностные насосы для отвода загрязненных сточных вод

обновление 15.02.2023

Модель	Мощность		Рабочее колесо - нерж. ст. SS304		Рабочее колесо - чугун	
	Серия	(кВт)	Артикул	Цена розница (USD) с НДС	Артикул	Цена розница (USD) с НДС
SP-2(1150)	4	1.1	SP-2MSHRC(1150)	<b>5 119.80</b>	SP-2MQHRC(1150)	<b>4 721.33</b>
SP-2(1450)*	4	1.5	SP-2MSHRC(1450)*	<b>5 219.95</b>	SP-2MQHRC(1450)*	<b>4 821.48</b>
SP-2(1750)	2	3	SP-2MSHRC(1750)	<b>5 525.08</b>	SP-2MQHRC(1750)	<b>5 126.61</b>
SP-2(2050)	2	4.0	SP-2MSHRC(2050)	<b>5 670.73</b>	SP-2MQHRC(2050)	<b>5 272.26</b>
SP-2(2350)	2	7.5	SP-2MSHRC(2350)	<b>6 077.09</b>	SP-2MQHRC(2350)	<b>5 678.62</b>
SP-2(2650)	2	7.5	SP-2MSHRC(2650)	<b>6 080.76</b>	SP-2MQHRC(2650)	<b>5 682.29</b>
SP-2(2900)*	2	9.2	SP-2MSHRC(2900)*	<b>6 283.51</b>	SP-2MQHRC(2900)*	<b>5 885.04</b>

Модель	Мощность		Рабочее колесо - нерж. ст. SS304		Рабочее колесо - чугун	
	Серия	(кВт)	Артикул	Цена розница (USD) с НДС	Артикул	Цена розница (USD) с НДС
SP-3(650)	4	0.75	SP-3MSHRC(650)	<b>5 920.18</b>	SP-3MQHRC(650)	<b>5 481.86</b>
SP-3(750)*	8	1.5	SP-3MSHRC(750)*	<b>6 370.63</b>	SP-3MQHRC(750)*	<b>5 932.31</b>
SP-3(850)	4	1.5	SP-3MSHRC(850)	<b>6 030.33</b>	SP-3MQHRC(850)	<b>5 592.01</b>
SP-3(950)*	6	1.5	SP-3MSHRC(950)*	<b>6 210.20</b>	SP-3MQHRC(950)*	<b>5 771.88</b>
SP-3(1050)	4	3.0	SP-3MSHRC(1050)	<b>6 298.08</b>	SP-3MQHRC(1050)	<b>5 859.76</b>
SP-3(1150)	4	4.0	SP-3MSHRC(1150)	<b>6 456.62</b>	SP-3MQHRC(1150)	<b>6 018.30</b>
SP-3(1250)	4	4.0	SP-3MSHRC(1250)	<b>6 477.80</b>	SP-3MQHRC(1250)	<b>6 039.48</b>
SP-3(1350)	4	5.5	SP-3MSHRC(1350)	<b>6 886.52</b>	SP-3MQHRC(1350)	<b>6 448.20</b>
SP-3(1450)	4	5.5	SP-3MSHRC(1450)	<b>6 693.64</b>	SP-3MQHRC(1450)	<b>6 255.32</b>
SP-3(1550)	2	7.5	SP-3MSHRC(1550)	<b>6 911.24</b>	SP-3MQHRC(1550)	<b>6 472.92</b>
SP-3(1650)	2	11.0	SP-3MSHRC(1650)	<b>7 473.35</b>	SP-3MQHRC(1650)	<b>7 035.03</b>
SP-3(1750)	2	11.0	SP-3MSHRC(1750)	<b>7 484.49</b>	SP-3MQHRC(1750)	<b>7 046.17</b>
SP-3(1850)	2	15.0	SP-3MSHRC(1850)	<b>7 856.56</b>	SP-3MQHRC(1850)	<b>7 418.24</b>
SP-3(1950)	2	15.0	SP-3MSHRC(1950)	<b>7 801.76</b>	SP-3MQHRC(1950)	<b>7 363.45</b>
SP-3(2050)	2	18.5	SP-3MSHRC(2050)	<b>8 091.53</b>	SP-3MQHRC(2050)	<b>7 653.21</b>
SP-3(2150)	2	18.5	SP-3MSHRC(2150)	<b>8 194.83</b>	SP-3MQHRC(2150)	<b>7 756.52</b>

Модель	Мощность		Рабочее колесо - нерж. ст. SS304		Рабочее колесо - чугун	
	Серия	(кВт)	Артикул	Цена розница (USD) с НДС	Артикул	Цена розница (USD) с НДС
SP-4(650)	4	1.5	SP-4MSHRC(650)	<b>6 535.40</b>	SP-4MQHRC(650)	<b>6 057.23</b>
SP-4(750)*	8	1.5	SP-4MSHRC(750)*	<b>6 960.52</b>	SP-4MQHRC(750)*	<b>6 482.36</b>
SP-4(850)	4	2.2	SP-4MSHRC(850)	<b>6 671.04</b>	SP-4MQHRC(850)	<b>6 192.87</b>
SP-4(950)*	6	3.0	SP-4MSHRC(950)*	<b>7 257.74</b>	SP-4MQHRC(950)*	<b>6 779.58</b>
SP-4(1050)	4	5.5	SP-4MSHRC(1050)	<b>7 253.71</b>	SP-4MQHRC(1050)	<b>6 775.55</b>
SP-4(1150)	4	5.5	SP-4MSHRC(1150)	<b>7 297.93</b>	SP-4MQHRC(1150)	<b>6 819.77</b>
SP-4(1250)	4	7.5	SP-4MSHRC(1250)	<b>7 513.64</b>	SP-4MQHRC(1250)	<b>7 035.48</b>
SP-4(1350)	4	11.0	SP-4MSHRC(1350)	<b>8 136.62</b>	SP-4MQHRC(1350)	<b>7 658.45</b>
SP-4(1450)*	4	11.0	SP-4MSHRC(1450)*	<b>7 909.49</b>	SP-4MQHRC(1450)*	<b>7 431.33</b>
SP-4(1550)	2	15.0	SP-4MSHRC(1550)	<b>8 499.64</b>	SP-4MQHRC(1550)	<b>8 021.48</b>



SP-4(1650)	2	18.5	SP-4MSHRC(1650)	<b>8 649.86</b>	SP-4MQHRC(1650)	<b>8 171.70</b>
SP-4(1750)	2	22.0	SP-4MSHRC(1750)	<b>9 255.24</b>	SP-4MQHRC(1750)	<b>8 777.07</b>
SP-4(1850)	2	30.0	SP-4MSHRC(1850)	<b>11 209.89</b>	SP-4MQHRC(1850)	<b>10 731.72</b>
SP-4(1950)	2	30.0	SP-4MSHRC(1950)	<b>11 697.03</b>	SP-4MQHRC(1950)	<b>11 218.87</b>

Модель	Мощность		Рабочее колесо - нерж. ст. SS304		Рабочее колесо - чугун	
	Серия	(кВт)	Артикул	Цена розница (USD) с НДС	Артикул	Цена розница (USD) с НДС
SP-6(650)	4	3.0	SP-6MSHRC(650)	<b>7 663.46</b>	SP-6MQHRC(650)	<b>7 145.45</b>
SP-6(750)*	8	4.0	SP-6MSHRC(750)*	<b>9 173.33</b>	SP-6MQHRC(750)*	<b>8 655.32</b>
SP-6(850)	4	7.5	SP-6MSHRC(850)	<b>8 820.22</b>	SP-6MQHRC(850)	<b>8 302.21</b>
SP-6(950)*	6	7.5	SP-6MSHRC(950)*	<b>9 229.19</b>	SP-6MQHRC(950)*	<b>8 711.18</b>
SP-6(1050)	4	11.0	SP-6MSHRC(1050)	<b>9 272.70</b>	SP-6MQHRC(1050)	<b>8 754.69</b>
SP-6(1150)	4	15.0	SP-6MSHRC(1150)	<b>9 715.28</b>	SP-6MQHRC(1150)	<b>9 197.27</b>
SP-6(1250)	4	22.0	SP-6MSHRC(1250)	<b>11 572.61</b>	SP-6MQHRC(1250)	<b>11 054.60</b>
SP-6(1350)	4	30.0	SP-6MSHRC(1350)	<b>13 309.58</b>	SP-6MQHRC(1350)	<b>12 791.57</b>
SP-6(1450)*	4	30.0	SP-6MSHRC(1450)*	<b>11 486.66</b>	SP-6MQHRC(1450)*	<b>10 968.65</b>
SP-6(1550)	4	37.0	SP-6MSHRC(1550)	<b>13 888.52</b>	SP-6MQHRC(1550)	<b>13 370.51</b>

Модель	Мощность		Рабочее колесо - нерж. ст. SS304		Рабочее колесо - чугун	
	Серия	(кВт)	Артикул	Цена розница (USD) с НДС	Артикул	Цена розница (USD) с НДС
SP-8(650)	6	7.5	SP-8MSHRC(650)	---	SP-8MQHRC(650)	<b>18 259.14</b>
SP-8(750)*	8	11	SP-8MSHRC(750)*	---	SP-8MQHRC(750)*	<b>18 511.94</b>
SP-8(850)	6	15	SP-8MSHRC(850)	---	SP-8MQHRC(850)	<b>19 853.34</b>
SP-8(950)*	6	22	SP-8MSHRC(950)*	---	SP-8MQHRC(950)*	<b>19 793.93</b>
SP-8(1050)	4	30	SP-8MSHRC(1050)	---	SP-8MQHRC(1050)	<b>22 276.60</b>
SP-8(1150)	4	37	SP-8MSHRC(1150)	---	SP-8MQHRC(1150)	<b>23 214.52</b>
SP-8(1250)	4	55	SP-8MSHRC(1250)	---	SP-8MQHRC(1250)	<b>25 879.86</b>
SP-8(1350)	4	75	SP-8MSHRC(1350)	---	SP-8MQHRC(1350)	<b>28 210.95</b>
SP-8(1450)*	4	75	SP-8MSHRC(1450)*	---	SP-8MQHRC(1450)*	<b>24 455.96</b>

Модель	Мощность		Рабочее колесо - нерж. ст. SS304		Рабочее колесо - чугун	
	Серия	(кВт)	Артикул	Цена розница (USD) с НДС	Артикул	Цена розница (USD) с НДС
SP-10(650)	6	11	SP-1MSHRC(650)	---	SP-1MQHRC(650)	<b>20 932.43</b>
SP-10(750)*	8	15	SP-1MSHRC(750)*	---	SP-1MQHRC(750)*	<b>21 770.85</b>
SP-10(850)	6	22	SP-1MSHRC(850)	---	SP-1MQHRC(850)	<b>24 072.64</b>
SP-10(950)*	6	30	SP-1MSHRC(950)*	---	SP-1MQHRC(950)*	<b>23 580.98</b>
SP-10(1050)	4	45	SP-1MSHRC(1050)	---	SP-1MQHRC(1050)	<b>26 697.67</b>
SP-10(1150)	4	55	SP-1MSHRC(1150)	---	SP-1MQHRC(1150)	<b>28 382.83</b>
SP-10(1250)	4	75	SP-1MSHRC(1250)	---	SP-1MQHRC(1250)	<b>30 724.11</b>
SP-10(1350)	4	90	SP-1MSHRC(1350)	---	SP-1MQHRC(1350)	<b>31 585.61</b>
SP-10(1450)*	4	90	SP-1MSHRC(1450)*	---	SP-1MQHRC(1450)*	<b>27 941.44</b>

**SP насосная часть**

Модель	Рабочее колесо - нерж. ст. SS304		Рабочее колесо - чугун	
	Артикул	Цена розница (USD) с НДС	Артикул	Цена розница (USD) с НДС
SP-2	SP-2MSHRC	<b>3 706.84</b>	SP-2MQHRC	<b>3 318.33</b>
SP-3	SP-3MSHRC	<b>4 298.71</b>	SP-3MQHRC	<b>3 871.35</b>
SP-4	SP-4MSHRC	<b>4 683.24</b>	SP-4MQHRC	<b>4 217.04</b>
SP-6	SP-6MSHRC	<b>5 689.91</b>	SP-6MQHRC	<b>5 184.85</b>
SP-8	SP-8MSHRC	-	SP-8MQHRC	<b>12 435.27</b>
SP-10	SP-10MSHRC	<b>15 457.69</b>	SP-10MQHRC	<b>14 643.42</b>

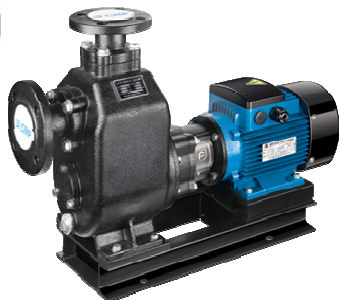

## ZW – Малозасоряемые самовсасывающие насосы

По умолчанию насосы комплектуются электродвигателем 50Гц/3х380В. Однофазное исполнение 50Гц/1х220: 0,37 кВт +89,34 USD к розн.; 0,55 кВт +89,34 USD к розн.; 0,75 кВт + 124,99 USD к розн.; 1,1 кВт +124,99 USD к розн.; 1,5 кВт +178,07 USD к розн.; 2,2 кВт +213,69 USD к розн.

**обновление**  
**15.02.2023**

Проточная часть чугун HT200		Проточная часть нерж. SS304		Мощность
Модель/Артикул	Цена розница (USD) с НДС	Модель/Артикул	Цена розница (USD) с НДС	
25ZW5-12	1 513.11	25ZWF5-12	2 827.79	0.75
25ZW8-18	1 643.45	25ZWF8-18	3 146.29	1.5
32ZW5-12	1 513.11	32ZWF5-12	2 827.79	0.75
32ZW10-10	1 516.70	32ZWF10-10	2 830.03	1.1
32ZW10-20	1 813.23	32ZWF10-20	3 146.29	2.2
32ZW10-30	2 002.25	32ZWF10-30	3 725.01	3
32ZW5-20	1 643.45	32ZWF5-20	3 146.29	1.5
32ZW8-18	1 643.45	32ZWF8-18	3 146.29	1.5
40ZW10-10	1 546.72	40ZWF10-10	3 004.72	1.1
40ZW15-10	1 546.72	40ZWF15-10	3 004.72	1.1
40ZW10-20	1 846.82	40ZWF10-20	3 285.58	2.2
40ZW15-18	1 846.82	40ZWF15-18	3 285.58	2.2
40ZW15-28	2 198.47	40ZWF15-28	3 725.01	3
40ZW20-13	1 846.82	40ZWF20-13	3 285.58	2.2
50ZW15-10	1 560.58	50ZWF15-10	3 032.93	1.1
50ZW10-20	1 846.82	50ZWF10-20	3 285.58	2.2
50ZW15-18	1 846.82	50ZWF15-18	3 285.58	2.2
50ZW15-28	2 198.47	50ZWF15-28	3 725.01	3
50ZW20-13	1 846.82	50ZWF20-13	3 285.58	2.2
50ZW20-40	3 066.09	50ZWF20-40	5 560.63	5.5
65ZW25-30	3 066.55	65ZWF25-30	5 611.69	5.5

65ZW25-40	<b>3 166.44</b>	65ZWF25-40	<b>5 660.06</b>	7.5
65ZW30-20	<b>2 769.55</b>	65ZWF30-20	<b>5 273.51</b>	4
65ZW40-25	<b>3 444.14</b>	---	---	7.5
80ZW40-16	<b>2 769.55</b>	80ZWF40-16	<b>5 273.51</b>	4
80ZW45-15	<b>3 095.65</b>	80ZWF45-15	<b>5 424.92</b>	5.5
80ZW40-25	<b>3 439.24</b>	80ZWF40-25	<b>6 059.61</b>	7.5
80ZW65-15	<b>3 160.61</b>	80ZWF65-15	<b>5 592.43</b>	7.5
80ZW65-25	<b>4 396.90</b>	80ZWF65-25	<b>7 734.01</b>	11
80ZW65-35	<b>4 571.59</b>	---	---	15
100ZW100-16	<b>4 807.65</b>	---	---	7.5
100ZW100-20	<b>5 256.49</b>	---	---	11
100ZW100-30	<b>6 457.39</b>	---	---	15
100ZW100-35	<b>5 871.95</b>	---	---	18.5
100ZW80-20	<b>5 309.33</b>	---	---	11
150ZW150-15	<b>6 917.42</b>	---	---	11
150ZW150-20	<b>7 505.09</b>	---	---	15
150ZW200-15	<b>7 912.71</b>	---	---	15
150ZW200-20	<b>8 711.39</b>	---	---	22
150ZW200-30	<b>10 160.89</b>	---	---	30
200ZW300-15	<b>10 022.49</b>	---	---	22
200ZW300-20	<b>11 860.35</b>	---	---	30



**QY/QYL – Самовсасывающие вихревые насосы-ФЛОТАТОРЫ из нержавеющей стали 50HZ**

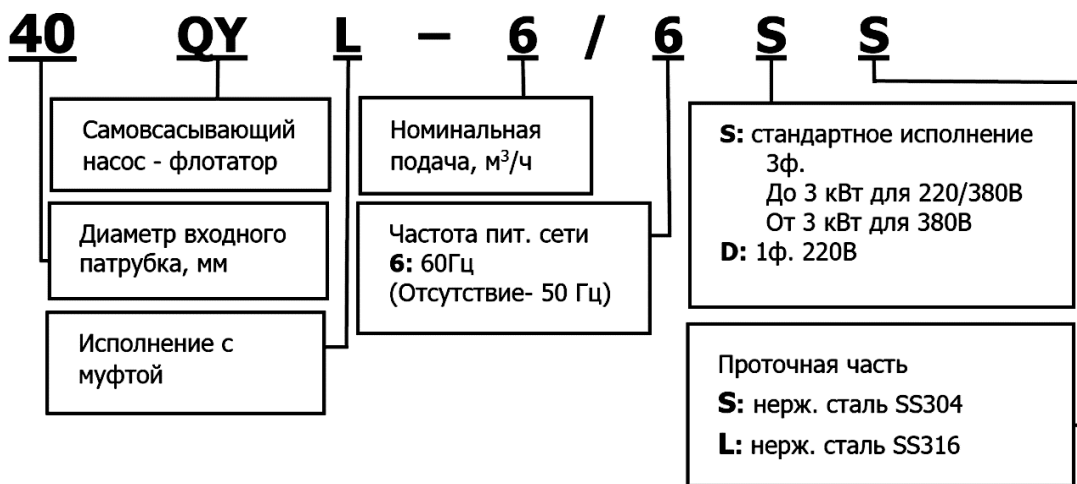

обновление 15.02.2023

Модель/Арт.	Мощность, кВт	Цена розница, USD с НДС
20QY-1SS	0.55	991.35
25QY-2SS	1.1	1 203.77
40QY-6SS	3	2 124.28
50QY-12SS	5.5	3 540.48

20QYL-1SS	0.55	1 784.39
25QYL-2SS	1.1	2 166.76
40QYL-6SS	4	3 894.49
50QYL-12SS	7.5	6 797.68

С каталогом и руководством по эксплуатации необходимо ознакомиться на сайте оф. представительства  
<https://www.cnprussia.ru/catalog/qy-qyl.html>



## Трехфазные асинхронные двигатели (низковольтные)

Примечание: Цена указана для двигателей типа **B3**; класс защиты **IP55**

Цена двигателей типа **B5, B14** +2% от цены **B3**, **B35, V1** (до типоразмера 160) +5%, (выше типоразмера 160) +3%, **V15** +7%.

Подготовка двигателя под установку датчиков +2% к стоимости.

обновление 15.02.2023

### Модель YE2 (IE2, IP55, GB3, IC411)

Модель/Арт.	Мощность, кВт	Ток, А	Частота, об/мин	КПД, %	Р.Ф.	Момент, Н·м	$T_{st}/T_N$	$T_{max}/T_N$	$I_{st}/I_N$	Цена розн., USD с НДС
<b>2-х полюсные. 3000 об/мин - 50 Гц</b>										
YE2-80M1-2	0.75	1.8	2855	77.4	0.82	2.4	2.3	2.3	6.8	182.74
YE2-80M2-2	1.1	2.5	2860	79.6	0.83	3.5	2.3	2.3	7.1	198.45
YE2-90S-2	1.5	3.3	2890	81.3	0.84	4.8	2.3	2.3	7.3	234.83
YE2-90L-2	2.2	4.7	2890	83.2	0.85	7	2.3	2.3	7.6	265.72
YE2-100L-2	3	6.2	2880	84.6	0.87	9.6	2.2	2.3	7.8	358.86
YE2-112M-2	4	8	2910	85.8	0.88	12.7	2.2	2.3	8.1	444.85
YE2-132S1-2	5.5	10.9	2905	87	0.88	17.5	2.2	2.3	8.2	599.48
YE2-132S2-2	7.5	14.5	2915	88.1	0.89	23.9	2.2	2.3	7.8	673.89
YE2-160M1-2	11	21	2935	89.4	0.89	35	2.2	2.3	7.9	1 037.99
YE2-160M2-2	15	28.4	2935	90.3	0.89	47.8	2.2	2.3	7.9	1 191.32
YE2-160L-2	18.5	34.7	2935	90.9	0.89	58.9	2.2	2.3	8	1 352.68
YE2-180M-2	22	41.1	2950	91.3	0.89	70	2.2	2.3	8.1	1 717.89
YE2-200L1-2	30	55.7	2960	92	0.89	95.5	2	2.3	7.5	2 294.34
YE2-200L2-2	37	68.3	2960	92.5	0.89	118	2	2.3	7.5	2 562.47
YE2-225M-2	45	82.7	2965	92.9	0.89	143	2.2	2.3	7.5	3 290.59
YE2-250M-2	55	100.7	2970	93.2	0.89	175	2.2	2.3	7.6	3 901.14
YE2-280S-2	75	136.5	2975	93.8	0.89	239	1.8	2.3	6.9	4 824.74
YE2-280M-2	90	163.3	2975	94.1	0.89	287	1.8	2.3	6.9	5 430.83
YE2-315S-2	110	197	2975	94.3	0.9	350	1.8	2.2	7	9 429.54
YE2-315M-2	132	236	2975	94.6	0.9	420	1.8	2.2	7	10 133.20
YE2-315L1-2	160	282	2975	94.8	0.91	509	1.8	2.2	7.1	11 407.39
YE2-315L-2	185	325	2975	95	0.91	589	1.8	2.2	7.1	13 313.85
YE2-315L2-2	200	352	2975	95	0.91	637	1.8	2.2	7.1	12 812.35
YE2-355M1-2	220	387	2980	95	0.91	700	1.6	2.2	7.1	18 647.83
YE2-355M2-2	250	439	2980	95	0.91	796	1.6	2.2	7.1	20 659.51
YE2-355L1-2	280	492	2980	95	0.91	891	1.6	2.2	7.1	21 098.27
YE2-355L2-2	315	554	2980	95	0.91	1003	1.6	2.2	7.2	22 998.81
YE2-3551-2	355	624	2980	95	0.91	1130	1.6	2.2	7.2	по запросу
YE2-3552-2	375	659	2980	95	0.91	1194	1.6	2.2	7.2	

<b>4-х полюсные. 1500 об/мин - 50 Гц</b>										
YE2-80M1-4	0.55	1.5	1415	77.1	0.75	3.5	2.3	2.3	6.4	<b>174.47</b>
YE2-80M2-4	0.75	1.9	1415	79.6	0.76	4.8	2.3	2.3	6.4	<b>189.35</b>
YE2-90S-4	1.1	2.7	1425	81.4	0.77	7	2.3	2.3	6.6	<b>227.39</b>
YE2-90L-4	1.5	3.5	1425	82.8	0.78	9.6	2.3	2.3	6.7	<b>256.89</b>
YE2-100L1-4	2.2	5	1440	84.3	0.8	14	2.3	2.3	7.3	<b>338.19</b>
YE2-100L2-4	3	6.6	1440	85.5	0.81	19.1	2.3	2.3	7.5	<b>378.11</b>
YE2-112M-4	4	8.7	1445	86.6	0.81	25.5	2.3	2.3	7.5	<b>464.81</b>
YE2-132S-4	5.5	11.6	1455	87.7	0.82	35	2	2.3	7.5	<b>628.42</b>
YE2-132M-4	7.5	15.5	1455	88.7	0.83	47.8	2	2.3	7.3	<b>722.50</b>
YE2-160M-4	11	22.4	1465	89.8	0.83	70	2	2.3	7.4	<b>1 096.60</b>
YE2-160L-4	15	30	1465	90.6	0.84	95.5	2	2.3	7.5	<b>1 288.46</b>
YE2-180M-4	18.5	36.3	1470	91.2	0.85	118	2	2.3	7.6	<b>1 627.23</b>
YE2-180L-4	22	42.9	1470	91.6	0.85	140	2.1	2.3	7.7	<b>1 782.17</b>
YE2-200L-4	30	58.1	1475	92.3	0.85	191	2.1	2.3	7.1	<b>2 380.24</b>
YE2-225S-4	37	70.5	1480	92.7	0.86	236	2.1	2.3	7.3	<b>2 924.52</b>
YE2-225M-4	45	85.4	1480	93.1	0.86	287	2.2	2.3	7.3	<b>3 252.86</b>
YE2-250M-4	55	104	1480	93.5	0.86	350	2.2	2.3	7.3	<b>3 836.48</b>
YE2-280S-4	75	139	1485	94	0.87	478	2.2	2.3	6.8	<b>4 877.68</b>
YE2-280M-4	90	165	1485	94.2	0.88	573	2.2	2.3	6.9	<b>5 557.64</b>
YE2-315S-4	110	199	1485	94.5	0.89	700	2.1	2.2	6.9	<b>8 951.79</b>
YE2-315M-4	132	238	1485	94.7	0.89	840	2.1	2.2	6.9	<b>10 060.42</b>
YE2-315L1-4	160	285	1485	94.9	0.9	1019	2.1	2.2	6.9	<b>11 559.53</b>
YE2-315L-4	185	328	1485	95.1	0.9	1178	2.1	2.2	6.9	<b>12 660.91</b>
YE2-315L2-4	200	355	1485	95.1	0.9	1273	2.1	2.2	6.9	<b>13 070.85</b>
YE2-355M1-4	220	391	1490	95.1	0.9	1401	2	2.2	6.8	<b>17 971.01</b>
YE2-355M2-4	250	444	1490	95.1	0.9	1592	2	2.2	6.8	<b>18 490.41</b>
YE2-355L1-4	280	497	1490	95.1	0.90 t	1783	2	2.2	6.8	<b>19 729.09</b>
YE2-355L2-4	315	559	1490	95.1	0.9	2006	2	2.2	6.8	<b>20 722.93</b>
YE2-3551-4	355	637	1490	95.1	0.89	2260	1.7	2.2	6.5	<b>по запросу</b>
YE2-3552-4	375	681	1490	95.1	0.88 1	2388	1.7	2.2	6.5	
<b>6-ти полюсные. 1000 об/мин - 50 Гц</b>										
YE2-80M1-6	0.37	1.3	900	62	0.7	3.5	1.9	2	4.7	<b>175.81</b>
YE2-80M2-6	0.55	1.8	900	65	0.72	5.3	1.9	2.1	4.7	<b>193.47</b>
YE2-90S-6	0.75	2.1	940	75.9	0.71	7.2	2	2.1	5.8	<b>231.52</b>
YE2-90L-6	1.1	3	940	78.1	0.72	10.5	2	2.1	5.9	<b>268.13</b>
YE2-100L-6	1.5	4	950	79.8	0.72	14.3	2	2.1	5.9	<b>345.63</b>
YE2-112M-6	2.2	5.7	955	81.8	0.72	21	2	2.1	6.2	<b>432.45</b>
YE2-132S-6	3	7.6	970	83.3	0.72	28.7	2	2.1	6.4	<b>573.84</b>
YE2-132M1-6	4	9.7	970	84.6	0.74	38.2	2	2.1	6.6	<b>660.66</b>
YE2-132M2-6	5.5	13	970	86	0.75	52.5	2	2.1	6.8	<b>744.18</b>
YE2-160M-6	7.5	16.8	975	87.2	0.78	71.6	2	2.1	6.8	<b>1 044.33</b>
YE2-160L-6	11	23.9	975	88.7	0.79	105	2	2.1	6.9	<b>1 262.77</b>
YE2-180L-6	15	31	980	89.7	0.82	143	2	2.1	7.3	<b>1 641.68</b>
YE2-200L1-6	18.5	38.9	980	90.4	0.8	177	2	2.1	7.2	<b>2 030.77</b>
YE2-200L2-6	22	45.4	980	90.9	0.81	210	2	2.1	7.3	<b>2 198.81</b>
YE2-225M-6	30	60.6	985	91.7	0.82	287	2	2.1	6.8	<b>2 880.37</b>
YE2-250M-6	37	73.5	985	92.2	0.83	353	2	2.1	7	<b>3 517.47</b>
YE2-280S-6	45	86.8	990	92.7	0.85	430	2	2	7.2	<b>4 370.79</b>
YE2-280M-6	55	104	990	93.1	0.86	525	2	2	7.2	<b>4 989.29</b>
YE2-315S-6	75	145	990	93.7	0.84	716	2	2	6.5	<b>9 007.01</b>
YE2-315M-6	90	171	990	94	0.85	860	2	2	6.6	<b>9 957.67</b>
YE2-315L1-6	110	209	990	94.1	0.85	1051	2	2	6.6	<b>11 344.87</b>
YE2-315L2-6	132	247	990	94.7	0.86	1261	2	2	6.6	<b>12 404.54</b>
YE2-355M1-6	160	298	990	94.8	0.86	1528	2	2	6.7	<b>17 060.65</b>
YE2-355M2-6	185	344	990	94.9	0.86	1767	2	2	6.7	<b>17 722.14</b>
YE2-355M3-6	200	372	990	95	0.86	1910	2	2	6.8	<b>18 524.19</b>

YE2-355L1-6	220	409	990	95	0.86	2101	2	2	6.8	19 602.84
YE2-355L2-6	250	465	990	95	0.86	2388	2	2	6.8	22 947.43
YE2-355L4-6	280	492	990	95	0.91	2674	2	2	6.8	32 248.92
YE2-3552-6	315	586	990	95	0.86	3008	2	2	6.8	32 907.06
YE2-3553-6	355	660	990	95	0.86	3390	2	2	6.8	по запросу
<b>8-ми полюсные. 750 об/мин - 50 Гц</b>										
YE2-132S-8	2.2	6	705	77.6	0.71	28	1.8	2	6	607.74
YE2-132M-8	3	7.9	705	80	0.73	38.2	1.8	2	6	694.40
YE2-160M1-8	4	10.3	720	81.9	0.73	50.9	1.9	2	6	933.53
YE2-160M2-8	5.5	13.6	720	83.8	0.74	70	2	2	6	1 026.14
YE2-160L-8	7.5	17.8	720	85.3	0.75	95.5	2	2	6.6	1 201.76
YE2-180L-8	11	25.1	730	86.9	0.76	140	2	2	6.6	1 609.07
YE2-200L-8	15	34.1	730	88	0.76	191	2	2	6.6	2 295.55
YE2-225S-8	18.5	41.1	730	88.6	0.76	236	1.9	2	6.6	2 581.46
YE2-225M-8	22	47.4	730	89.1	0.78	280	1.9	2	6.6	2 802.50
YE2-250M-8	30	63.4	730	89.8	0.79	382	1.9	2	6.6	3 748.98
YE2-280S-8	37	77.8	730	90.3	0.81	471	1.9	2	6.6	4 729.97
YE2-280M-8	45	94.1	740	90.7	0.81	573	1.9	2	6.6	5 317.61
YE2-315S-8	55	113	740	91	0.82	700	2	2	6.6	8 329.81
YE2-315M-8	75	154	740	91.6	0.82	955	2	2	6.6	9 830.83
YE2-315L1-8	90	182	740	91.9	0.82	1146	2	2	6.6	11 139.49
YE2-315L2-8	110	221	740	92.3	0.82	1401	2	2	6.6	12 203.66
YE2-355M1-8	132	264	740	92.6	0.82	1681	2	2	6.6	16 157.71
YE2-355M2-8	160	319	740	93	0.82	2037	2	2	6.7	19 237.79
YE2-355L-8	200	392	740	93.5	0.83	2547	2	2	6.8	20 683.13
YE2-3551-8	220	431	740	93.5	0.83	2801	2	2	6.8	по запросу
YE2-3552-8	250	490	740	93.5	0.83	3183	2	2	6.8	
<b>10-ти полюсные. 600 об/мин - 50 Гц</b>										
YE2-315S-10	45	101	594	90.2	0.75	716	2	2	7.2	8 690.32
YE2-315M-10	55	123	594	90.5	0.75	875	2	2	7.2	9 545.30
YE2-315L1-10	75	165	594	91.1	0.76	1194	2	2	6.5	12 976.92
YE2-315L2-10	90	194	594	91.4	0.77	1433	2	2	6.6	по запросу
YE2-355M1-10	110	233	590	91.8	0.78	1751	2	2	6.6	
YE2-355M2-10	132	279	590	92.1	0.78	2101	2	2	6.6	
YE2-355L-10	160	337	590	92.5	0.78	2547	2	2	6.7	
YE2-3551-10	185	390	590	92.5	0.78	2945	2	2	6.7	
YE2-3552-10	200	421	590	92.5	0.78	3183	2	2	6.8	

### Модель YE3 (IE3, IP55, GB2, IC411)

2-х полюсные. 3000 об/мин - 50 Гц										
YE3-80M1-2	0.75	1.7	2885	80.7	0.82	2.4	2.3	2.3	7	258.11
YE3-80M2-2	1.1	2.4	2885	82.7	0.83	3.5	2.2	2.3	7.3	290.38
YE3-90S-2	1.5	3.2	2905	84.2	0.84	4.8	2.2	2.3	7.6	360.29
YE3-90L-2	2.2	4.6	2905	85.9	0.85	7	2.2	2.3	7.6	419.43
YE3-100L-2	3	6	2895	87.1	0.87	9.6	2.2	2.3	7.8	516.22
YE3-112M-2	4	7.8	2915	88.1	0.88	12.7	2.2	2.3	8.3	645.28
YE3-132S1-2	5.5	10.6	2925	89.2	0.88	17.5	2	2.3	8.3	871.12
YE3-132S2-2	7.5	14.4	2925	90.1	0.88	23.9	2	2.3	7.8	1 032.45
YE3-160M 1-2	11	20.6	2950	91.2	0.89	35	2	2.3	8.1	1 645.46
YE3-160M2-2	15	27.9	2950	91.9	0.89	47.8	2	2.3	8.1	1 833.66
YE3-160L-2	18.5	34.2	2950	92.4	0.89	58.9	2	2.3	8.2	2 064.89
YE3-180M-2	22	40.5	2960	92.7	0.89	70	2	2.3	8.2	2 839.23
YE3-200L1-2	30	54.9	2965	93.3	0.89	95.5	2	2.3	7.6	3 290.93
YE3-200L2-2	37	67.4	2965	93.7	0.89	118	2	2.3	7.6	3 613.56
YE3-225M-2	45	80.8	2965	94	0.9	143	2	2.3	7.7	4 194.31
YE3-250M-2	55	98.5	2970	94.3	0.9	175	2	2.3	7.7	5 226.75
YE3-280S-2	75	134	2975	94.7	0.9	239	1.8	2.3	7.1	7 646.56

YE3-280M-2	90	160	2975	95	0.9	287	1.8	2.3	7.1	<b>8 388.62</b>
YE3-315S-2	110	195	2980	95.2	0.9	350	1.8	2.3	7.1	<b>13 550.86</b>
YE3-315M-2	132	234	2980	95.4	0.9	420	1.8	2.3	7.1	<b>14 744.61</b>
YE3-315L1-2	160	279	2980	95.6	0.91	509	1.8	2.3	7.2	<b>15 809.33</b>
YE3-315L2-2	200	349	2980	95.8	0.91	637	1.8	2.2	7.2	<b>16 970.83</b>
YE3-355M-2	250	436	2985	95.8	0.91	796	1.6	2.2	7.2	<b>27 585.67</b>
YE3-355L-2	315	549	2985	95.8	0.91	1003	1.6	2.2	7.2	<b>29 682.82</b>
YE3-3551-2	355	619	2985	95.8	0.91	1130	1.6	2.2	7.2	по запросу
YE3-3552-2	375	654	2985	95.8	0.91	1194	1.6	2.2	7.2	
<b>4-х полюсные. 1500 об/мин - 50 Гц</b>										
YE3-80M2-4	0.75	1.8	1435	82.5	0.75	4.8	2.3	2.3	6.6	<b>290.38</b>
YE3-90S-4	1.1	2.6	1435	84.1	0.76	7	2.3	2.3	6.8	<b>387.17</b>
YE3-90L-4	1.5	3.5	1435	85.3	0.77	9.6	2.3	2.3	7	<b>451.69</b>
YE3-100L1-4	2.2	4.8	1450	86.7	0.81	14	2.3	2.3	7.6	<b>580.76</b>
YE3-100L2-4	3	6.3	1450	87.7	0.82	19.1	2.3	2.3	7.6	<b>645.28</b>
YE3-112M-4	4	8.4	1455	88.6	0.82	25.5	2.2	2.3	7.8	<b>774.33</b>
YE3-132S-4	5.5	11.2	1465	89.6	0.83	35	2	2.3	7.9	<b>1 064.71</b>
YE3-132M-4	7.5	15	1465	90.4	0.84	47.8	2	2.3	7.5	<b>1 258.29</b>
YE3-160M-4	11	21.5	1470	91.4	0.85	70	2.2	2.3	7.7	<b>1 677.72</b>
YE3-160L-4	15	28.8	1470	92.1	0.86	95.5	2.2	2.3	7.8	<b>2 032.63</b>
YE3-180M-4	18.5	35.3	1475	92.6	0.86	118	2	2.3	7.8	<b>2 581.12</b>
YE3-180L-4	22	41.8	1475	93	0.86	140	2	2.3	7.8	<b>2 839.23</b>
YE3-200L-4	30	56.6	1475	93.6	0.86	191	2	2.3	7.3	<b>3 581.29</b>
YE3-225S-4	37	69.6	1480	93.9	0.86	236	2	2.3	7.4	<b>4 285.72</b>
YE3-225M-4	45	84.4	1480	94.2	0.86	287	2	2.3	7.4	<b>4 646.01</b>
YE3-250M-4	55	103	1485	94.6	0.86	350	2.2	2.3	7.4	<b>5 742.98</b>
YE3-280S-4	75	136	1485	95	0.88	478	2	2.3	6.9	<b>8 130.51</b>
YE3-280M-4	90	163	1485	95.2	0.88	573	2	2.3	6.9	<b>9 130.69</b>
YE3-315S-4	110	197	1485	95.4	0.89	700	2	2.2	7	<b>14 067.08</b>
YE3-315M-4	132	236	1485	95.6	0.89	840	2	2.2	7	<b>15 712.54</b>
YE3-315L1-4	160	285	1485	95.8	0.89	1019	2	2.2	7.1	<b>16 583.66</b>
YE3-315L2-4	200	352	1485	96	0.9	1273	2	2.2	7.1	<b>18 487.23</b>
YE3-355M-4	250	440	1490	96	0.9	1592	2	2.2	7.1	<b>26 037.00</b>
YE3-355L-4	315	554	1490	96	0.9	2006	2	2.2	7.1	<b>29 682.82</b>
YE3-3551-4	355	638	1490	96	0.88	2260	1.7	2.2	7	по запросу
YE3-3552-4	375	674	1490	96	0.88	2388	1.7	2.2	7	
<b>6-ти полюсные. 1000 об/мин - 50 Гц</b>										
YE3-90S-6	0.75	2	950	78.9	0.71	7.2	2	2.1	6	<b>387.17</b>
YE3-90L-6	1.1	2.8	950	81	0.73	10.5	2	2.1	6	<b>451.69</b>
YE3-100L-6	1.5	3.8	960	82.5	0.73	14.3	2	2.1	6.5	<b>516.22</b>
YE3-112M-6	2.2	5.4	960	84.3	0.74	21	2	2.1	6.6	<b>709.80</b>
YE3-132S-6	3	7.2	970	85.6	0.74	28.7	2	2.1	6.8	<b>838.87</b>
YE3-132M1-6	4	9.5	970	86.8	0.74	38.2	2	2.1	6.8	<b>1 000.18</b>
YE3-132M2-6	5.5	12.7	970	88	0.75	52.5	2	2.1	7	<b>1 161.50</b>
YE3-160M-6	7.5	16.2	975	89.1	0.79	71.6	2	2.1	7	<b>1 580.94</b>
YE3-160L-6	11	23.1	975	90.3	0.8	105	2	2.1	7.2	<b>1 903.57</b>
YE3-180L-6	15	30.9	980	91.2	0.81	143	2	2.1	7.3	<b>2 548.85</b>
YE3-200L1-6	18.5	37.8	980	91.7	0.81	177	2	2.1	7.3	<b>3 065.07</b>
YE3-200L2-6	22	44.8	980	92.2	0.81	210	2	2.1	7.4	<b>3 355.45</b>
YE3-225M-6	30	59.1	985	92.9	0.83	287	2	2.1	6.9	<b>4 065.25</b>
YE3-250M-6	37	71.7	985	93.3	0.84	353	2	2.1	7.1	<b>4 968.64</b>
YE3-280S-6	45	85.8	990	93.7	0.85	430	2	2	7.3	<b>6 646.37</b>
YE3-280M-6	55	103	990	94.1	0.86	525	2	2	7.3	<b>7 420.70</b>
YE3-315S-6	75	143	990	94.6	0.84	716	2	2	6.6	<b>11 937.65</b>
YE3-315M-6	90	170	990	94.9	0.85	860	2	2	6.7	<b>13 034.63</b>
YE3-315L1-6	110	207	990	95.1	0.85	1051	2	2	6.7	<b>14 416.59</b>
YE3-315L2-6	132	245	990	95.4	0.86	1261	2	2	6.8	<b>15 777.06</b>
YE3-355M1-6	160	296	990	95.6	0.86	1528	1.8	2	6.8	<b>23 165.50</b>



УЕЗ-355М2-6	200	365	990	95.8	0.87	1910	1.8	2	6.8	25 811.14
УЕЗ-355L-6	250	456	990	95.8	0.87	2388	1.8	2	6.8	29 360.18

## Комплектующие для мониторинга состояния

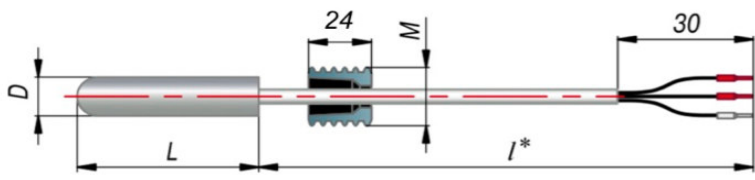
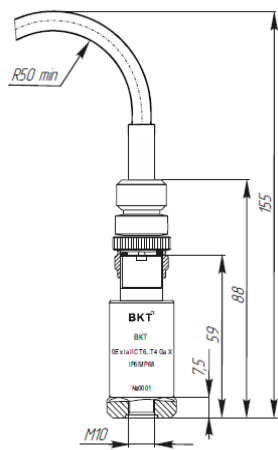
Модель	Артикул	Цена розн., USD с НДС
<p>Датчик температуры РТ100 (ДТС034Э2-РТ100.В3.25/1,5) (Э2-штука резьбовая длиной 24 мм)</p>  <p>Модель ДТС034Э2-РТ100.В3.25/1,5 Э2 - штука резьбовая длиной 24мм D=5 мм, M=8x1 мм, L=25 мм, l=1,5 м</p>	--	110
<p>Вибропреобразователь ВКТ-10 СКЗ виброскорости 0-30 мм/с. Частотный диапазон 10-1000 Гц. Выходной сигнал 4-20мА (токовая петля). Разъем MIL-2 (вилка)</p> 	--	1210
в комплекте: Шпилька монтажная M10x1/M8x1,0	--	
в комплекте: Кабельная сборка 1,5 метра	--	
Магнитное основание ВКТ-10 (на плоскость и цилиндрическую поверхность)	--	165



## Системы автоматизации Aikon **НОВОЕ ПОКОЛЕНИЕ**

обновление 15.02.2023

Модель	PD ES	PD E	PD SS
Возможность одновременной работы нескольких насосов в режиме PBS	Да (до 6 насосов)	Нет (только через контроллер)	Нет
Диапазон мощностей	1.5 - 560 кВт	1.5 - 560 кВт	0.75 - 2.2 кВт
Питание ЧП	3x380В	3x380В	1x220В
Питание двигателей	3x380В	3x380В	3x220В
Степень защиты	<b>IP 20/IP 65</b>	<b>IP 20</b>	<b>IP 65</b>

С контроллерами серии PD ES IP65 мощностью до 7.5 кВт включительно поставляется пластина для установки на клеммную коробку и вводной автомат, до 22 кВт включительно только вводной автомат. Свыше 30 кВт включительно в комплект поставки входит только контроллер.

Мощность двигателя насоса, кВт	Ток, А	PD ES IP20		PD ES IP65		PD E IP20	
		Артикул	Цена розница, USD с НДС	Артикул	Цена розница, USD с НДС	Артикул	Цена розница, USD с НДС
1.5	3.7	PD ES 1.5 IP20	<b>342.43</b>	PD ES 1.5 IP65	<b>574.69</b>	PD E 1.5 IP20	<b>325.31</b>
2.2	5	PD ES 2.2 IP20	<b>369.05</b>	PD ES 2.2 IP65	<b>591.39</b>	PD E 2.2 IP20	<b>350.60</b>
4	8.5	PD ES 4 IP20	<b>445.28</b>	PD ES 4 IP65	<b>786.20</b>	PD E 4 IP20	<b>423.02</b>
5.5	13	PD ES 5.5 IP20	<b>529.98</b>	PD ES 5.5 IP65	<b>847.42</b>	PD E 5.5 IP20	<b>503.48</b>
7.5	18	PD ES 7.5 IP20	<b>583.22</b>	PD ES 7.5 IP65	<b>865.51</b>	PD E 7.5 IP20	<b>554.06</b>
11	24	PD ES 11 IP20	<b>901.45</b>	PD ES 11 IP65	<b>1 191.12</b>	PD E 11 IP20	<b>856.38</b>
15	30	PD ES 15 IP20	<b>1 058.75</b>	PD ES 15 IP65	<b>1 280.18</b>	PD E 15 IP20	<b>1005.81</b>
18.5	37	PD ES 18.5 IP20	<b>1 247.51</b>	PD ES 18.5 IP65	<b>1 314.97</b>	PD E 18.5 IP20	<b>1185.13</b>
22	46	PD ES 22 IP20	<b>1 481.04</b>	PD ES 22 IP65	<b>1 995.29</b>	PD E 22 IP20	<b>1406.99</b>
30	58	PD ES 30 IP20	<b>1 772.65</b>	PD ES 30 IP65	<b>2 315.94</b>	PD E 30 IP20	<b>1684.02</b>
37	75	PD ES 37 IP20	<b>2 171.95</b>	PD ES 37 IP65	<b>2 606.34</b>	PD E 37 IP20	<b>2063.35</b>
45	90	PD ES 45 IP20	<b>2 647.48</b>	PD ES 45 IP65	<b>3 176.98</b>	PD E 45 IP20	<b>2515.11</b>
55	110	PD ES 55 IP20	<b>3 222.23</b>	PD ES 55 IP65	<b>3 866.68</b>	PD E 55 IP20	<b>3061.12</b>
75	150	PD ES 75 IP20	<b>4 418.92</b>	PD ES 75 IP65	<b>5 302.70</b>	PD E 75 IP20	<b>4197.97</b>
90	170	PD ES 90 IP20	<b>5 005.77</b>	PD ES 90 IP65	<b>6 006.92</b>	PD E 90 IP20	<b>4755.48</b>
110	210	PD ES 110 IP20	<b>6 451.72</b>	PD ES 110 IP65	<b>7 742.06</b>	PD E 110 IP20	<b>6129.13</b>
132	250	PD ES 132 IP20	<b>8 197.75</b>	PD ES 132 IP65	<b>9 837.30</b>	PD E 132 IP20	<b>7787.86</b>
160	300	PD ES 160 IP20		PD ES 160 IP65		PD E 160 IP20	
185	340	PD ES 185 IP20		PD ES 185 IP65		PD E 185 IP20	
200	380	PD ES 200 IP20		PD ES 200 IP65		PD E 200 IP20	
220	430	PD ES 220 IP20		PD ES 220 IP65		PD E 220 IP20	
250	465	PD ES 250 IP20		PD ES 250 IP65		PD E 250 IP20	
280	520	PD ES 280 IP20		PD ES 280 IP65		PD E 280 IP20	
315	585	PD ES 315 IP20	по запросу	PD ES 315 IP65	по запросу	PD E 315 IP20	по запросу
355	650	PD ES 355 IP20		PD ES 355 IP65		PD E 355 IP20	
400	754	PD ES 400 IP20		PD ES 400 IP65		PD E 400 IP20	
450	850	PD ES 450 IP20		PD ES 450 IP65		PD E 450 IP20	

500	930	PD ES 500 IP20
560	1050	PD ES 560 IP20

PD ES 500 IP65
PD ES 560 IP65

PD E 500 IP20
PD E 560 IP20

### PD SS (220)

Мощность двигателя , кВт	Артикул	Ток вход/выход, А	Цена розница, USD с НДС
0.75	PD SS 0.75	8,2/5	<b>277.09</b>
1.5	PD SS 1.5	14/7	<b>284.35</b>
2.2	PD SS 2.2	23/10	<b>296.45</b>

### Устройства плавного пуска AIKON CMC-MX

Мощность двигателя , кВт	Артикул	Ток вход/выход, А	Цена розница, USD с НДС
15	CMC-015/3-MX	30	<b>684.20</b>
18.5	CMC-018/3-MX	39	<b>716.10</b>
22	CMC-022/3-MX	45	<b>729.30</b>
30	CMC-030/3-MX	60	<b>862.40</b>
37	CMC-037/3-MX	76	<b>889.90</b>
45	CMC-045/3-MX	90	<b>1 118.70</b>
55	CMC-055/3-MX	110	<b>1 285.90</b>
75	CMC-075/3-MX	150	<b>1 453.10</b>
90	CMC-090/3-MX	180	<b>2 796.20</b>
110	CMC-110/3-MX	218	<b>2 922.70</b>
132	CMC-132/3-MX	260	<b>3 176.80</b>
160	CMC-160/3-MX	320	<b>3 304.40</b>
185	CMC-185/3-MX	370	<b>3 752.10</b>
220	CMC-220/3-MX	440	<b>3 940.20</b>
250	CMC-250/3-MX	500	<b>4 387.90</b>



Принадлежности для контроллеров	Артикул	Цена розница, USD с НДС
Сенсорная панель управления PD H диагональ 7 дюймов	PD H 7	<b>363</b>
Сенсорная панель управления PD H диагональ 10 дюймов	PD H 10	<b>540.87</b>
Контроллер PD P	PD P	<b>363</b>
Модуль связи PD G (для подключения к облачному серверу контроллеров PD R)	PD G	<b>296.45</b>
Система контроля состояния PD C (для передачи информации с датчиков в облачный сервер)	PD C	<b>484</b>



Системы управления насосными станциями и системы контроля состояния насосов	Артикул	Цена розница, USD с НДС
Система контроля состояния ЩУН PDC-8-M (для передачи информации с датчиков в облачный сервер)	ЩУН PDC-8-M	1827.1
Система контроля состояния ЩУН PDC-8-S (для передачи информации с датчиков в облачный сервер)	ЩУН PDC-8-S	1435.5
Система контроля состояния ЩУН PDC-16-M (для передачи информации с датчиков в облачный сервер)	ЩУН PDC-16-M	1960.2
Система контроля состояния ЩУН PDC-16-S (для передачи информации с датчиков в облачный сервер)	ЩУН PDC-16-S	1568.6
Щкаф с PD H-7 (HMI-Панель включена в стоимость шкафа)	ЩУН-PD H-7	676.5
Щкаф с PD H-10 (HMI-Панель включена в стоимость шкафа)	ЩУН-PD H-10	847
<b>Дополнительные опции для ЩУН PDH</b>		
Модуль связи PD G mini для подключения к PD H		165
Расширение протокола Modbus		550



Датчики давления	Артикул	Цена розница, USD с НДС
Датчик дифференциального давления <b>SPD</b> , перепад давления макс 3 Атм, , 4...20 мА, +24 В, резьба 2xG1/4", без кабеля погрешность 0,5%.	SPD 0-3bar	363
Датчик дифференциального давления <b>SPD</b> , перепад давления макс 6 Атм, , 4...20 мА, +24 В, резьба 2xG1/4", без кабеля погрешность 0,5%.	SPD 0-6bar	363
Датчик давления <b>SP100</b> , 0...6 Атм, двухпроводный, 4...20 мА, +24 В, резьба G1/4", длина кабеля 1,5 м, погрешность 0,5%.	SP100 0-6bar	61.71
Датчик давления <b>SP100</b> , 0...10 Атм, двухпроводный, 4...20 мА, +24 В, резьба G1/4", длина кабеля 1,5 м, погрешность 0,5%.	SP100 0-10bar	61.71
Датчик давления <b>SP100</b> , 0...16 Атм, двухпроводный, 4...20 мА, +24 В, резьба G1/4", длина кабеля 1,5 м, погрешность 0,5%.	SP100 0-16bar	61.71
Датчик давления <b>SP100</b> , 0...25 Атм, двухпроводный, 4...20 мА, +24 В, резьба G1/4", длина кабеля 1,5 м, погрешность 0,5%.	SP100 0-25bar	77.22



Выходные дроссели (моторные)				Входные дроссели (сетевые)			
Модель/арт.	Мощность	Ток, А	Цена розница, USD с НДС	Модель/арт.	Мощность	Ток, А	Цена розница, USD с НДС
STOCL-00030-ALU2100-4L	0.75	3	<b>142.52</b>	STACL-00037-ALM840-4L	0.75	3.7	<b>86.63</b>
STOCL-00050-ALU2000-4L	1.5	5	<b>153.00</b>	STACL-00050-ALM420-4L	1.5	5	<b>92.40</b>
STOCL-00065-ALU1500-4L	2.2	7,5	<b>177.45</b>	STACL-00075-ALM300-4L	2.2	7.5	<b>117.98</b>
STOCL-0011-ALU1200-4L	4	11	<b>216.57</b>	STACL-0010-ALM220-4L	3.7	10	<b>163.35</b>
STOCL-0016-ALU900-4L	5.5	16	<b>270.36</b>	STACL-0015-ALM142-4L	5.5	15	<b>297.83</b>
STOCL-0020-ALU700-4L	7.5	20	<b>291.32</b>	STACL-0020-ALM108-4L	7.5	20	<b>319.28</b>
STOCL-0030-ALU650-4L	11	30	<b>323.46</b>	STACL-0030-ALM70-4L	11	30	<b>344.03</b>
STOCL-0040-ALU600-4L	15	40	<b>373.76</b>	STACL-0040-ALM53-4L	15	40	<b>356.40</b>
STOCL-0050-ALU450-4L	18.5	50	<b>401.70</b>	STACL-0050-ALM42-4L	18.5	50	<b>381.98</b>
STOCL-0060-ALU350-4L	22	60	<b>444.32</b>	STACL-0060-ALM36-4L	22	60	<b>428.18</b>
STOCL-0080-ALU100-4L	30	80	<b>489.03</b>	STACL-0080-ALM26-4L	30	80	<b>462.00</b>
STOCL-0100-ALU90-4L	37	100	<b>519.07</b>	STACL-0100-ALM24-4L	37	100	<b>504.08</b>
STOCL-0120-ALU80-4L	45	100	<b>558.19</b>	STACL-0120-ALM18-4L	45	120	<b>604.73</b>
STOCL-0150-ALU65-4L	55	150	<b>595.91</b>	STACL-0150-ALM15-4L	55	150	<b>671.55</b>
STOCL-0200-ALU40-4L	75	200	<b>625.26</b>	STACL-0200-ALM11-4L	75	200	<b>825.00</b>
STOCL-0230-ALU35-4L	90	230	<b>711.18</b>	STACL-0230-ALM10-4L	90	230	<b>906.68</b>
STOCL-0250-ALU30-4L	110	250	<b>746.12</b>	STACL-0250-ALM09-4L	110	250	<b>965.25</b>
STOCL-0280-ALU25-4L	132	280	<b>835.54</b>	STACL-0280-ALM08-4L	132	280	<b>1154.18</b>
STOCL-0330-ALU20-4L	160	330	<b>1030.45</b>	STACL-0330-ALM06-4L	160	330	<b>1237.50</b>
STOCL-0360-ALU16-4L	187	360	<b>1119.87</b>	STACL-0360-ALM05-4L	187	360	<b>1301.03</b>
STOCL-0400-ALU13-4L	200	400	<b>1172.97</b>	STACL-0400-ALM045-4L	200	400	<b>1385.18</b>
STOCL-0450-ALU11-4L	220	450	<b>1244.22</b>	STACL-0450-ALM04-4L	220	450	<b>1511.40</b>
STOCL-0500-ALU09-4L	250	500	<b>1346.92</b>	STACL-0500-ALM03-4L	250	500	<b>1720.95</b>
STOCL-0600-ALU07-4L	280	600	<b>1386.04</b>	STACL-0600-ALM025-4L	280	600	<b>1805.10</b>
STOCL-0650-ALU06-4L	315	650	<b>1511.09</b>	STACL-0650-ALM022-4L	315	650	<b>1901.63</b>
STOCL-0750-ALU055-4L	400	750	<b>1768.18</b>	STACL-0750-ALM02-4L	400	750	<b>2140.88</b>
STOCL-1000-ALU045-4L	500	1000	<b>2651.22</b>	STACL-1000-ALM019-4L	500	1000	<b>3190.28</b>
STOCL-1250-ALU035-4L	630	1250	<b>3305.12</b>	STACL-1180-ALM015-4L	630	1180	<b>3987.23</b>
STOCL-1400-ALU025-4L	710	1400	<b>3646.74</b>	STACL-1400-ALM012-4L	710	1400	<b>4407.15</b>
STOCL-1600-ALU015-4L	800	1600	<b>3877.29</b>	STACL-1600-ALM010-4L	800	1600	<b>5456.55</b>



обновление 15.02.2023

## Щиты управления ЩУН КНС

ЩУН – КНС – МАКС – 2х11кВт – УХЛ4 – М – Д



### ЩУН КНС МИНИ

Наименование	Цена розница, USD с НДС	
	УХЛ4-А	УХЛ1(0)-А
ЩУН-КНС-МИНИ-2x0,75кВт	1336.50	1639.00
ЩУН-КНС-МИНИ-2x1,5кВт	1336.50	1639.00
ЩУН-КНС-МИНИ-2x2,2кВт	1336.50	1639.00
ЩУН-КНС-МИНИ-2x4кВт	1369.50	1672.00
ЩУН-КНС-МИНИ-2x5,5кВт	1369.50	1672.00
ЩУН-КНС-МИНИ-2x7,5кВт	1413.50	1716.00
ЩУН-КНС-МИНИ-2x11кВт	1435.50	1738.00
ЩУН-КНС-МИНИ-2x15кВт	1611.50	1991.00
ЩУН-КНС-МИНИ-2x18,5кВт	2029.50	2354.00
ЩУН-КНС-МИНИ-2x22кВт	4075.50	4686.00
ЩУН-КНС-МИНИ-2x30кВт	4922.50	5533.00
ЩУН-КНС-МИНИ-2x37кВт	4988.50	5599.00
ЩУН-КНС-МИНИ-2x45кВт	5890.50	6600.00
ЩУН-КНС-МИНИ-2x55кВт	6473.50	7172.00
ЩУН-КНС-МИНИ-2x75кВт	7562.50	8272.00
ЩУН-КНС-МИНИ-2x90кВт	20905.50	22836.00
ЩУН-КНС-МИНИ-2x110кВт	21532.50	23529.00

ЩУН-КНС-МИНИ-2х132кВт	23446.50	25454.00
ЩУН-КНС-МИНИ-2х160кВт	24337.50	26345.00
ЩУН-КНС-МИНИ-2х185кВт	По запросу	
ЩУН-КНС-МИНИ-2х200кВт		
ЩУН-КНС-МИНИ-2х220кВт		
ЩУН-КНС-МИНИ-2х250кВт		

<b>ЩУН КНС ОПТИ</b>		
Наименование	Цена розница, USD с НДС	
	УХЛ4-А	УХЛ1(0)-А
ЩУН-КНС-ОПТИ-2х0,75кВт	1848.00	2255.00
ЩУН-КНС-ОПТИ-2х1,5кВт	1848.00	2255.00
ЩУН-КНС-ОПТИ-2х2,2кВт	1848.00	2255.00
ЩУН-КНС-ОПТИ-2х4кВт	1881.00	2277.00
ЩУН-КНС-ОПТИ-2х5,5кВт	1881.00	2288.00
ЩУН-КНС-ОПТИ-2х7,5кВт	1925.00	2321.00
ЩУН-КНС-ОПТИ-2х11кВт	1947.00	2354.00
ЩУН-КНС-ОПТИ-2х15кВт	2123.00	2530.00
ЩУН-КНС-ОПТИ-2х18,5кВт	2585.00	2981.00
ЩУН-КНС-ОПТИ-2х22кВт	4576.00	5192.00
ЩУН-КНС-ОПТИ-2х30кВт	5445.00	6061.00
ЩУН-КНС-ОПТИ-2х37кВт	5511.00	6127.00
ЩУН-КНС-ОПТИ-2х45кВт	6369.00	7073.00
ЩУН-КНС-ОПТИ-2х55кВт	6941.00	7656.00
ЩУН-КНС-ОПТИ-2х75кВт	8041.00	8745.00
ЩУН-КНС-ОПТИ-2х90кВт	21340.00	23353.00
ЩУН-КНС-ОПТИ-2х110кВт	22033.00	24035.00
ЩУН-КНС-ОПТИ-2х132кВт	23947.00	25960.00
ЩУН-КНС-ОПТИ-2х160кВт	24827.00	26840.00
ЩУН-КНС-ОПТИ-2х185кВт	По запросу	
ЩУН-КНС-ОПТИ-2х200кВт		
ЩУН-КНС-ОПТИ-2х220кВт		
ЩУН-КНС-ОПТИ-2х250кВт		

<b>ЩУН КНС МАКС</b>		
Наименование	Цена розница, USD с НДС	
	УХЛ4-А	УХЛ1(0)-А
ЩУН-КНС-МАКС-2х0,75кВт	2266.00	3003.00
ЩУН-КНС-МАКС-2х1,5кВт	2266.00	3003.00
ЩУН-КНС-МАКС-2х2,2кВт	2266.00	3003.00
ЩУН-КНС-МАКС-2х4кВт	2288.00	3014.00

ЩУН-КНС-МАКС-2x5,5кВт	2288.00	3014.00
ЩУН-КНС-МАКС-2x7,5кВт	2321.00	3058.00
ЩУН-КНС-МАКС-2x11кВт	2354.00	3080.00
ЩУН-КНС-МАКС-2x15кВт	2519.00	3256.00
ЩУН-КНС-МАКС-2x18,5кВт	2651.00	3476.00
ЩУН-КНС-МАКС-2x22кВт	5016.00	6347.00
ЩУН-КНС-МАКС-2x30кВт	5885.00	7216.00
ЩУН-КНС-МАКС-2x37кВт	5951.00	7282.00
ЩУН-КНС-МАКС-2x45кВт	6820.00	8151.00
ЩУН-КНС-МАКС-2x55кВт	7436.00	8778.00
ЩУН-КНС-МАКС-2x75кВт	8536.00	9867.00
ЩУН-КНС-МАКС-2x90кВт	21769.00	24794.00
ЩУН-КНС-МАКС-2x110кВт	22539.00	25564.00
ЩУН-КНС-МАКС-2x132кВт	24453.00	24453.00
ЩУН-КНС-МАКС-2x160кВт	25333.00	25333.00
ЩУН-КНС-МАКС-2x185кВт	По запросу	
ЩУН-КНС-МАКС-2x200кВт		
ЩУН-КНС-МАКС-2x220кВт		
ЩУН-КНС-МАКС-2x250кВт		

Опции для ЩУН КНС МАКС	Цена розница, USD с НДС
GSM модем	550.00
Блок подключения датчиков утечки воды в маслокамеру	440.00



## ЗАПОРНАЯ АРМАТУРА Aikon

обновление 15.02.2023

Дисковый поворотный затвор Aikon IMB037				
Артикул	Диаметр, мм	Описание	Цена розн., USD с НДС	
			Ручной привод	Электропривод
IMB037 DN40	DN40	Макс. рабочее давление: 16 бар, рабочая температура: до 110 град.С, Корпус- чугун; диск- ковкий чугун, уплотнение - EPDM; шток - нерж. сталь. Начиная с DN200 с редуктором.	55.27	/
IMB037 DN50	DN50		53.38	/
IMB037 DN65	DN65		65.23	/
IMB037 DN80	DN80		71.91	/
IMB037 DN100	DN100		82.51	/
IMB037 DN125	DN125		98.35	/
IMB037 DN150	DN150		115.53	/
IMB037 DN200	DN200		301.46	/
IMB037 DN250	DN250		385.79	/
IMB037 DN300	DN300		518.57	/
IMB037 DN350	DN350		686.11	1 643.60
IMB037 DN400	DN400		1 103.72	2 082.06
IMB037 DN450	DN450		1 380.70	2 449.04
IMB037 DN500	DN500		1 742.31	2 870.43
IMB037 DN600	DN600	3 146.10	4 952.84	
IMB037 DN700	DN700	5 478.46	7 848.52	
IMB037 DN800	DN800	6 303.99	9 361.97	
IMB037 DN900	DN900	10 071.60	/	
IMB037 DN1000	DN1000	12 255.78	/	
IMB037 DN1200	DN1200	19 512.42	/	
Обратный клапан межфланцевый Aikon IMC021				
Артикул	Диаметр, мм	Описание	Цена розн., USD с НДС	
IMC021 DN40	DN40	Макс. рабочее давление: 16 бар, рабочая температура: 70- 120 град.С, Корпус, пластины- ковкий чугун, уплотнение - EPDM, шток и пружина - нерж. сталь	34.89	
IMC021 DN50	DN50		39.97	
IMC021 DN65	DN65		51.38	
IMC021 DN80	DN80		73.59	
IMC021 DN100	DN100		93.89	
IMC021 DN125	DN125		118.63	
IMC021 DN150	DN150		158.59	
IMC021 DN200	DN200		249.31	
IMC021 DN250	DN250		402.19	
IMC021 DN300	DN300		532.88	
IMC021 DN350	DN350		1 028.08	
IMC021 DN400	DN400		1 519.37	
IMC021 DN450	DN450		2 030.93	
IMC021 DN500	DN500		2 628.62	
IMC021 DN600	DN600		4 088.97	
IMC021 DN700	DN700		8 178.40	
IMC021 DN800	DN800	11 098.94		



**Задвижка с обрезиненным клином Alkon IMR001**

Артикул	Диаметр, мм	Описание	Цена розн., USD с НДС	
			Ручной привод	Электропривод
IMR001 DN40	DN40	Макс. рабочее давление: 16 бар, рабочая температура: до 110 град.С, Корпус- ковкий чугун; диск- ковкий чугун +EPDM, уплотнение - NBR, EPDM	108.86	/
IMR001 DN50	DN50		110.50	2 150.26
IMR001 DN65	DN65		138.93	2 187.86
IMR001 DN80	DN80		162.73	2 205.06
IMR001 DN100	DN100		195.88	2 266.88
IMR001 DN125	DN125		278.13	2 302.57
IMR001 DN150	DN150		307.67	2 514.79
IMR001 DN200	DN200		507.14	2 771.62
IMR001 DN250	DN250		796.10	3 407.01
IMR001 DN300	DN300		1 117.48	3 782.38
IMR001 DN350	DN350		2 034.47	4 852.41
IMR001 DN400	DN400		2 506.23	5 403.04
IMR001 DN450	DN450		3 950.99	7 785.28
IMR001 DN500	DN500		4 422.76	8 418.75
IMR001 DN600	DN600		7 622.47	12 774.71
IMR001 DN700	DN700		17 160.29	/



**Фильтр фланцевый Alkon IMS024**

Артикул	Диаметр, мм	Описание	Цена розн., USD с НДС
IMS024 DN50	DN50	Макс. рабочее давление: 16 бар, рабочая температура: до 110 град.С, Корпус и крышка - ковкий чугун, прокладка крышки- EPDM	104.97
IMS024 DN65	DN65		139.76
IMS024 DN80	DN80		163.94
IMS024 DN100	DN100		214.65
IMS024 DN125	DN125		316.67
IMS024 DN150	DN150		414.56
IMS024 DN200	DN200		730.05
IMS024 DN250	DN250		1 131.64
IMS024 DN300	DN300		1 638.19



**Обратный клапан шаровый Alkon IMC017 (для канализации)**

Артикул	Диаметр, мм	Описание	Цена розн., USD с НДС
IMC017 DN50	DN50	Макс. рабочее давление: 16 бар, Корпус, крышка- ковкий чугун, шар-WCB	101.43
IMC017 DN65	DN65		130.91
IMC017 DN80	DN80		162.76
IMC017 DN100	DN100		200.50
IMC017 DN125	DN125		372.69
IMC017 DN150	DN150		507.73
IMC017 DN200	DN200		804.94
IMC017 DN250	DN250		1 369.87
IMC017 DN300	DN300		1 819.82



Антивибрационная вставка Aikop IMX				
Артикул	Диаметр, мм	Описание	Цена розн., USD с НДС	
			1.0MPa	1.6MPa
IMX DN25	DN25	Макс. рабочее давление: 16 бар, фланцы: сталь SS; виброгасящая вставка: NR, EPDM, CR, NBR, FDFPM, IIR	38.10	38.10
IMX DN32	DN32		38.10	38.10
IMX DN40	DN40		42.70	42.70
IMX DN50	DN50		46.64	46.64
IMX DN65	DN65		60.43	60.43
IMX DN80	DN80		70.28	70.28
IMX DN100	DN100		86.05	86.05
IMX DN125	DN125		124.14	124.14
IMX DN150	DN150		151.73	151.73
IMX DN200	DN200		237.78	237.78
IMX DN250	DN250		320.54	375.72
IMX DN300	DN300		386.23	457.17
IMX DN350	DN350		543.21	589.85
IMX DN400	DN400		706.77	765.89
IMX DN450	DN450		862.44	937.98
IMX DN500	DN500		1 103.51	1 221.08
IMX DN600	DN600		1 310.41	1 510.75
IMX DN700	DN700		1 586.29	1 931.13
IMX DN800	DN800		2 034.92	2 586.67
IMX DN900	DN900		2 689.79	3 414.30
IMX DN1000	DN1000	3 262.57	4 138.15	
IMX DN1200	DN1200	4 345.05	6 000.31	
IMX DN1400	DN1400	5 745.45	0.00	



Шиберные задвижки Aikop IMR073H				
Артикул	Диаметр, мм	Описание	Цена розн., USD с НДС	
			Ручной привод/редуктор	Электропривод
IMX DN50	DN50	Корпус: чугун; зажимка: нержавеющая сталь AISI304.	200.75	/
IMX DN65	DN65		234.21	1 887.05
IMX DN80	DN80		294.44	/
IMX DN100	DN100		368.04	1 980.73
IMX DN125	DN125		424.92	/
IMX DN150	DN150		558.76	/
IMX DN200	DN200		742.78	/
IMX DN250	DN250		1 037.21	2 897.49
IMX DN300	DN300		1 304.88	/
IMX DN350	DN350		1 689.64	3 646.96
IMX DN400	DN400		2024,23/2748,93	/
IMX DN450	DN450		3 747.33	/
IMX DN500	DN500		4 884.92	6 818.81
IMX DN600	DN600		5 942.20	8 050.08
IMX DN700	DN700		10 037.50	12 500.03
IMX DN800	DN800		12 881.46	12 513.42
IMX DN900	DN900		19 272.00	21 312.96
IMX DN1000	DN1000		21 681.00	/
IMX DN1200	DN1200		30 052.28	/

